

# *BETA* MARINE

Seagoing

Saildrives

Inland Waterways

Marine Generating Sets

Spares & Support

## Your needs . . .

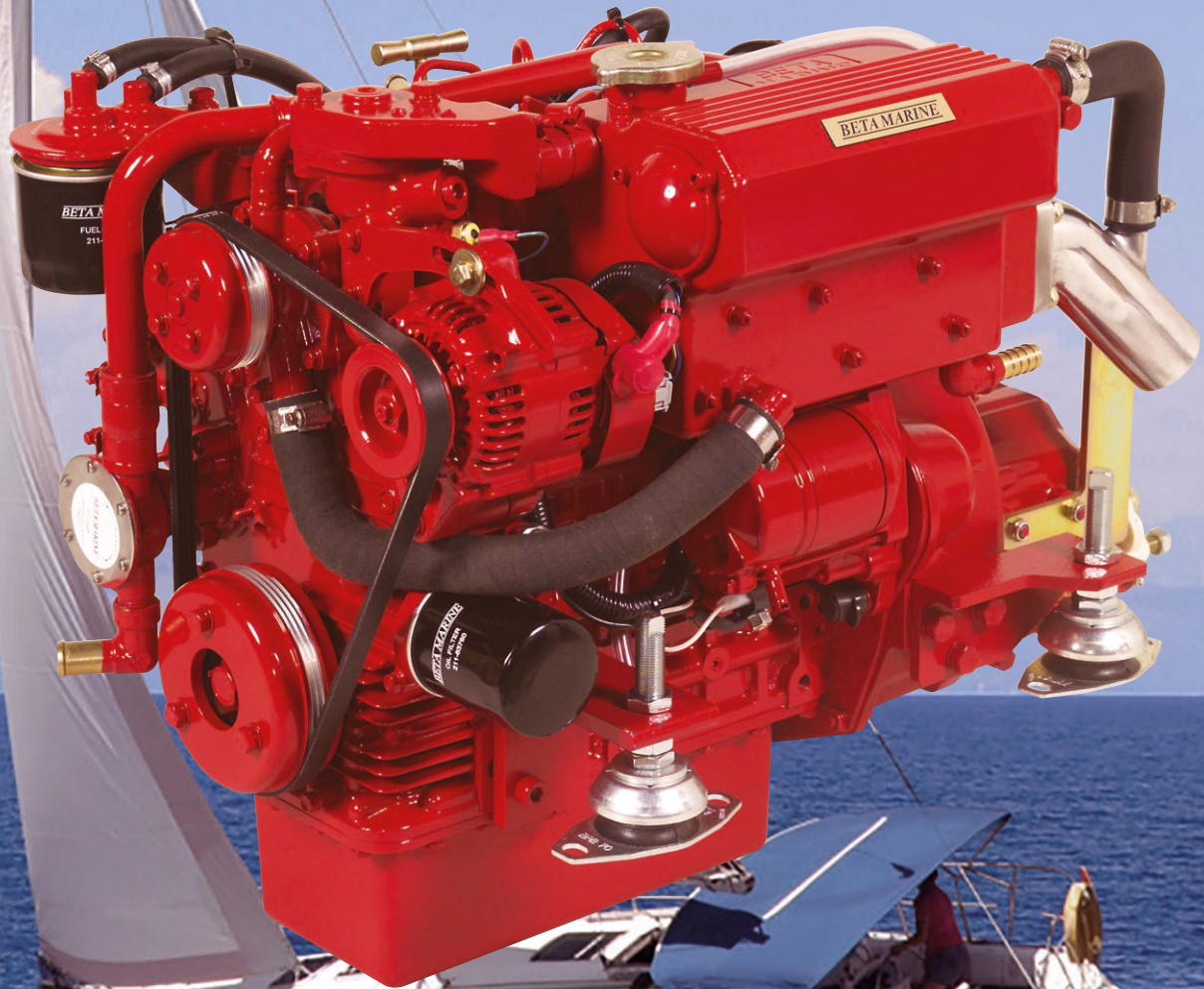

**. . . our tailored solutions  
delivering reliability and peace of mind**

## **Small Engine Range**

### **Heat Exchanger Cooled Beta 10 - Beta 45T**

## Why Beta Marine? Your needs . . .

- Our company has built its renowned reputation on over 30 years of customer centred focus, listening to maritime propulsion or power needs and providing value solutions. Proving our support & product at pre-purchase, during installation be it a new build or re-power and post-purchase with the delivery of an after sales service both nationally and internationally that is second to none.
- We value our employees equally as highly as our customers, are extremely proud of the retained bank of skills, experience and loyalty that we have built and have available in place today, which enables us to excel at providing maritime solutions to fit bespoke needs.
- Our company strives to continue to build our reputation with all our customers be they end users, dealers, international distributors or boat builders and our mission is simply to capture, retain and service your valued custom throughout our products natural life cycle.
- The combined experience of our dedicated seagoing team and dealer network, supported by state of the art computer aided design we have planned, installed and re-powered thousands of vessels and sit comfortably & confidently that we can support your unique needs and exceed your expectation.

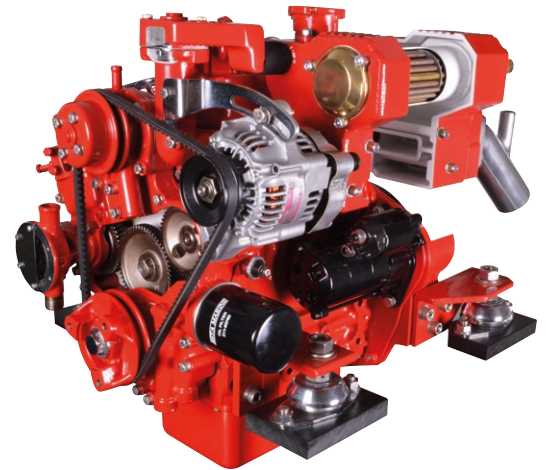
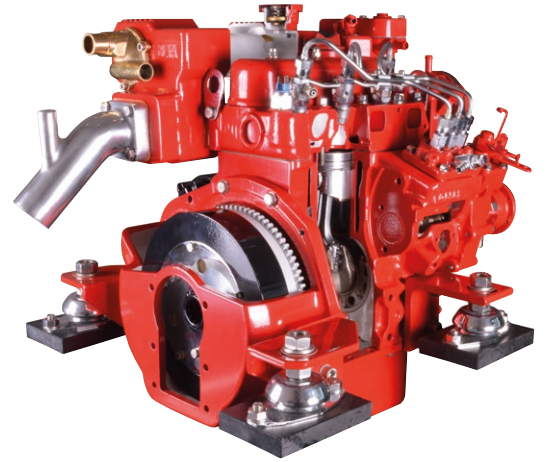

## . . . our tailored solutions delivering reliability and peace of mind

Beta Marine are an ISO Quality Assured Firm. Since 1987, we have been continually improving our Quality Procedures, whilst being monitored annually by ISO Quality Services Ltd.



ISO  
9001

Quality  
Management  
Certification

Cutaway Images Are For Illustration  
Purposes & Not Necessarily Representative

## The Beta 10 - Beta 45T Small Engine Range



- The Beta 10 - Beta 45T small-engine range is based upon technically advanced, high quality Kubota diesels that give you very smooth, quiet power, torque is immediate at low RPM and maximum power normally available at mid RPM. They are renowned for durability, longevity & reliability.
- Low carbon footprint, the Beta 10 - Beta 45T engine range meets all current and projected **RCD 2 (Recreational Craft Directive 2013/53/EU)** exhaust emission regulations.
- The Beta 14, 16, 20, 25, 30, 35 & 38, all meet **EPA (U.S Environmental Protection Agency)** exhaust emission compliance.

### RCD & EPA Compliance



Engine	EU Compliance - 2013/53/EU	BHP @ Max. RPM	kW @ Max. RPM	EPA Compliance - 40 CFR 1042	EPA BHP @ Max. RPM	EPA kW @ Max. RPM
Beta 10	RCD 2	10 @ 3,000	7.5 @ 3,000	-	-	-
Beta 14	RCD 2	13.5 @ 3,600	9.9 @ 3,600	EPA Tier 3	13 @ 3,600	9.9 @ 3,600
Beta 16	RCD 2	16 @ 3,600	12.0 @ 3,600	EPA Tier 3	16 @ 3,600	12.5 @ 3,600
Beta 20	RCD 2	20 @ 3,600	14.9 @ 3,600	EPA Tier 3	20 @ 3,600	14.9 @ 3,600
Beta 25	RCD 2	25 @ 3,600	18.5 @ 3,600	EPA Tier 3	25 @ 3,600	18.5 @ 3,600
Beta 30	RCD 2	30 @ 3,600	22.1 @ 3,600	EPA Tier 3	29 @ 3,600	21.7 @ 3,600
Beta 35	RCD 2	35 @ 2,800	26.0 @ 2,800	EPA Tier 3	33 @ 2,800	24.5 @ 2,800
Beta 38	RCD 2	38 @ 3,600	28.4 @ 3,600	EPA Tier 3	36 @ 3,600	27.0 @ 3,600
Beta 45T	RCD 2	45 @ 3,000	33.5 @ 3,000	-	-	-

## Small Engine Range - Specifications

2, 3 or 4 cylinders with high inertia flywheel for smooth running at low rpm.

Heater plugs for cold starting below 5°C, fuel filter, **MECHANICAL** fuel lift pump, **MECHANICAL** fuel injection pump and **MECHANICAL** engine governing ensures steadfast performance regardless of ambient conditions.

**QUIET GEAR DRIVEN CAMSHAFT** for maximum engine reliability and reduced servicing, as no timing chains or toothed belts have to be replaced.

Subject to criteria, Kubota based engines accommodate installation angles up to 15° maximum when static and 25° when heeling.

The Beta 10, 14, 16, 20 & 25 are equipped with a standard 40 Amp alternator, the Beta 30, 35, 38 & 45T are equipped with a standard 70 Amp alternator all are driven by a polyvee belt/pulley and achieve full power at cruising speed. **OPTIONAL OR ADDITIONAL ALTERNATORS** & polyvee belt/pulley drive transmission are available.

Optional special feet service, to ease planning and installation Beta Marine offer 3D computer aided modeling for the design & the manufacture of bespoke feet to allow direct installation on to your vessels existing engine bearers.

Mechanical & hydraulic, in-line, down angle or V drive gearbox options. Output rotation is clockwise in ahead, viewed from the gearbox end.

Cutaway Images Are For Illustration  
Purposes & Not Necessarily Representative

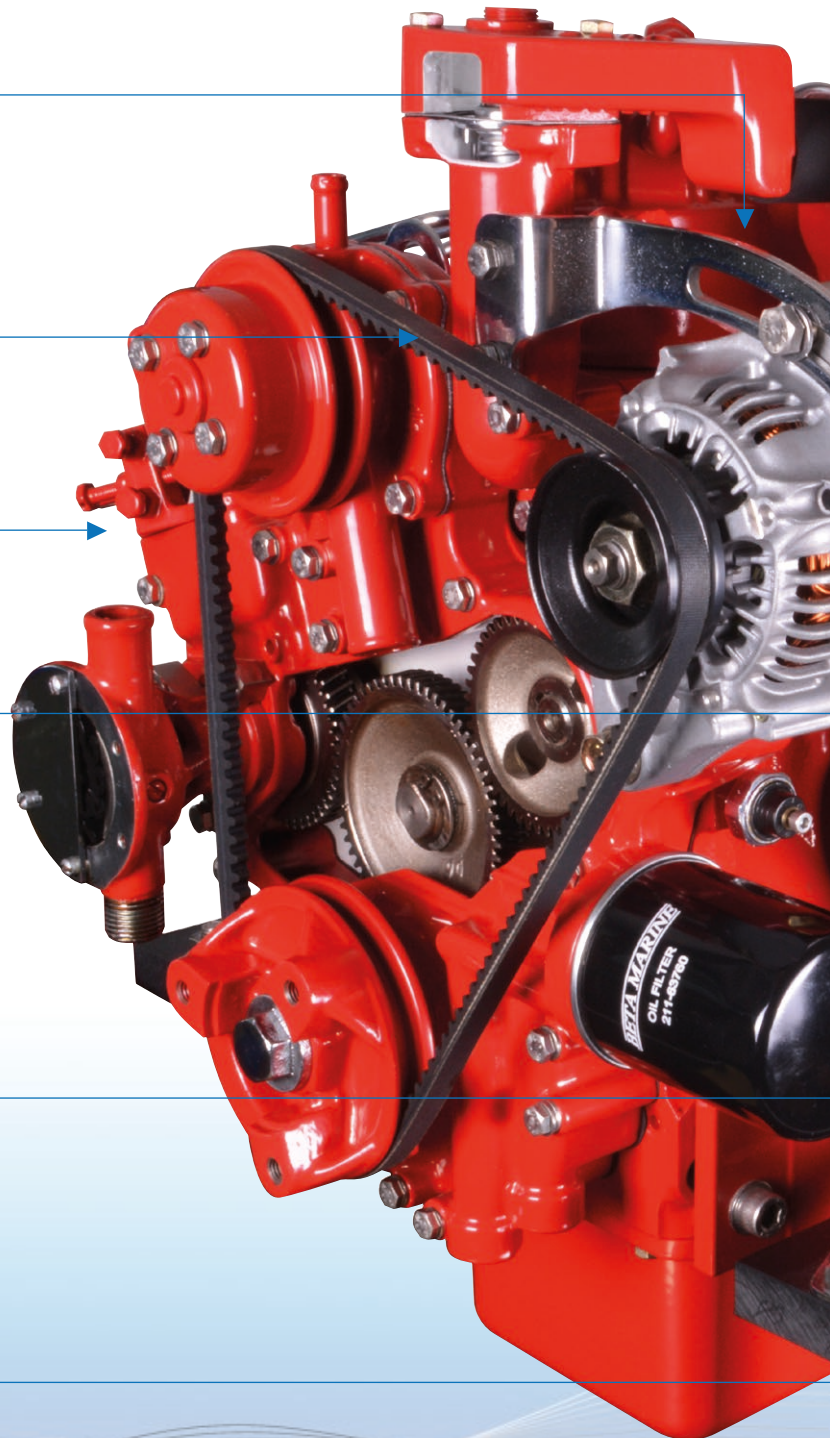

# BETA MARINE

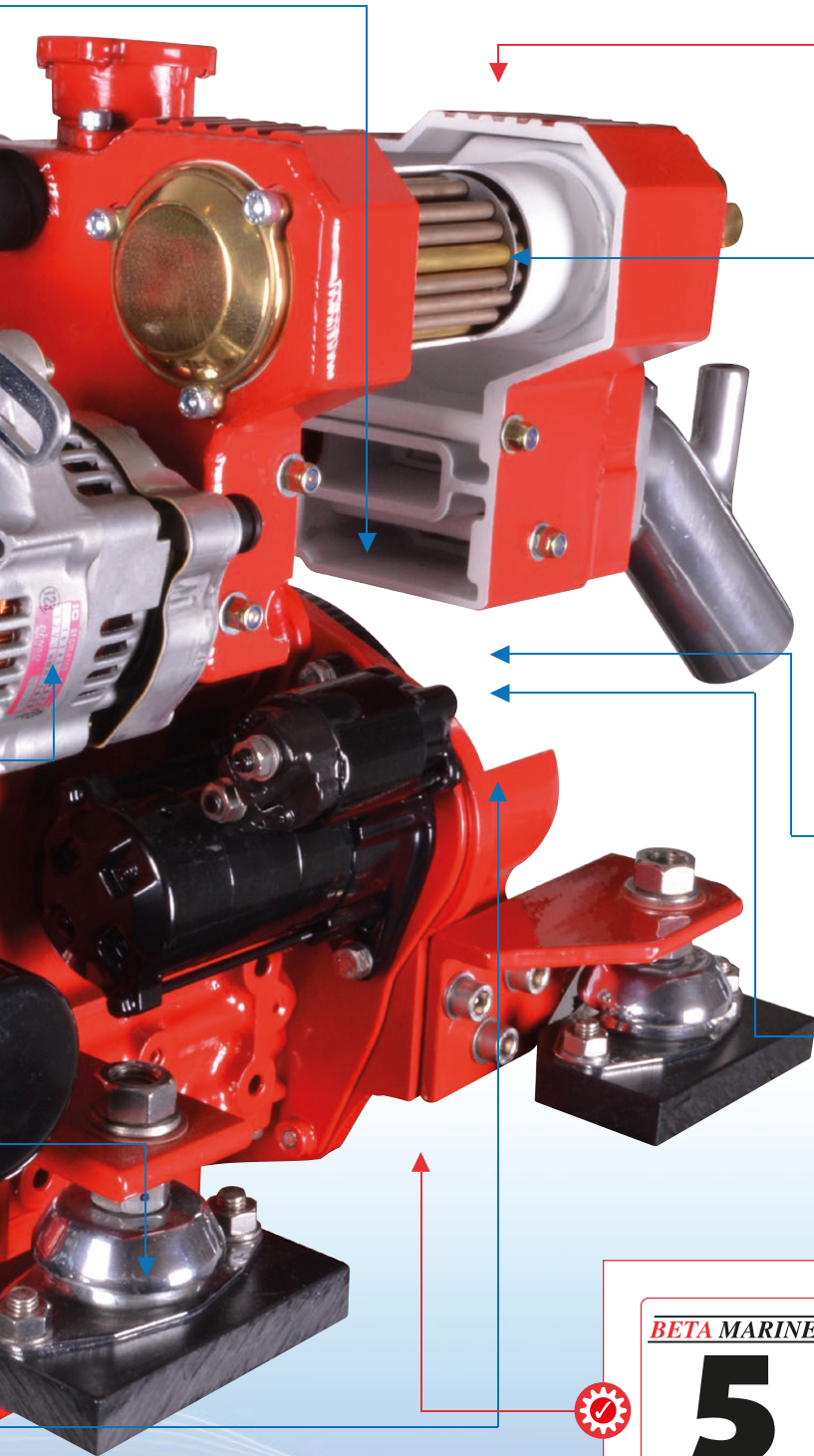

Complete with either "A" or "ABV" Control Panel & 3m of interconnection cable, "Morse" type engine speed and gearbox control brackets & end fittings. Heavy duty feet and flexible mountings. Please refer to relevant engine or control panel pages.

- **HEAT EXCHANGER COOLED**, the Beta 10, 14, 16, 20, 25, 30, 35 & 38 are naturally aspirated, whilst the Beta 45T is turbocharged.
- Three vortex combustion with indirect injection for quiet running, low emissions and excellent fuel consumption – Beta 10, 14, 16, 20, 25, 30, 35 & 38.
- ICVS combustion with direct injection for quiet running, low emissions and excellent fuel consumption – Beta 45T.



**BETA MARINE**

**5**

**YEAR 'SELF-SERVICE'  
ENGINE WARRANTY**





Subject to installation criteria & registration, Kubota based engine's used for recreational use benefit from a **5 YEAR 'SELF-SERVICE' ENGINE WARRANTY.**

# Beta 10



Recreational use only

## Kubota Base Engine

	<b>Cylinders</b>	2
	<b>Displacement</b>	479cc
	<b>Power</b>	10hp max @ 3,000rpm
	<b>Weight</b>	89Kg
	<b>Propeller</b>	AIA*

A general guidance for propeller size in inches, based upon 3 blade RH rotation and reduction ratio of 2:1. \*For accurate individual advice please provide us with your vessels current full specifications

BETA 10

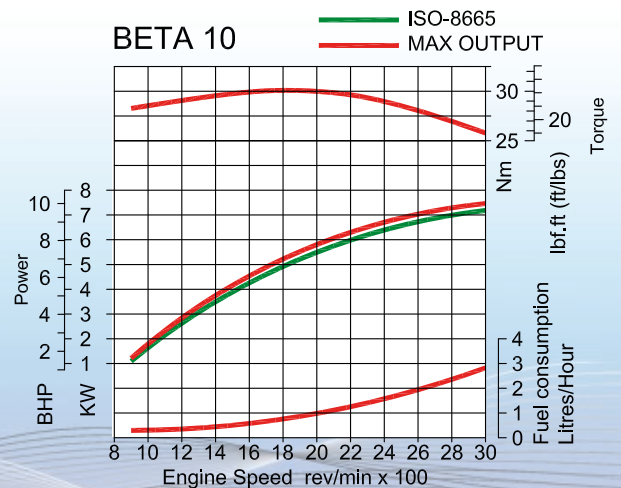

Based on theoretical propeller loading - matched at full speed

## Control Panel Options



A Panel	Std.	C Deluxe Panel	Opt.
ABV Panel	Opt.	CW Deluxe Panel	Opt.
ABVW Panel	Opt.	D Digital Panel	Opt.
B Panel	Opt.	Flybridge Control - Additional	
BW Panel	Opt.	C Panel & 6m Connection Cable	Opt.

## Electrical Options



40 Amp, 12 Volt Alternator	Std.	70 Amp, 12 Volt Insulated Return Alternator	Opt.
75 Amp, 12 Volt Alternator in Lieu of Standard	Opt.	125 Amp, 12 Volt Split Charging System	Opt.
120 Amp, 12 Volt Alternator in Lieu of Standard	Opt.		

## Gearbox Options



### Bobtail - No Gearbox

"Bobtail" Engine with Drive Plate and Housing Only **Std.**

### Technodrive / Twin Disc

TMC40 - Mechanical **Std.**

### PRM Marine

PRM60 - Mechanical **Std.**

PRM90 - Mechanical **Opt.**

PRM150 - Hydraulic **Opt.**

### ZF

ZF15MIV - 15° V Drive, Mechanical **Std.**

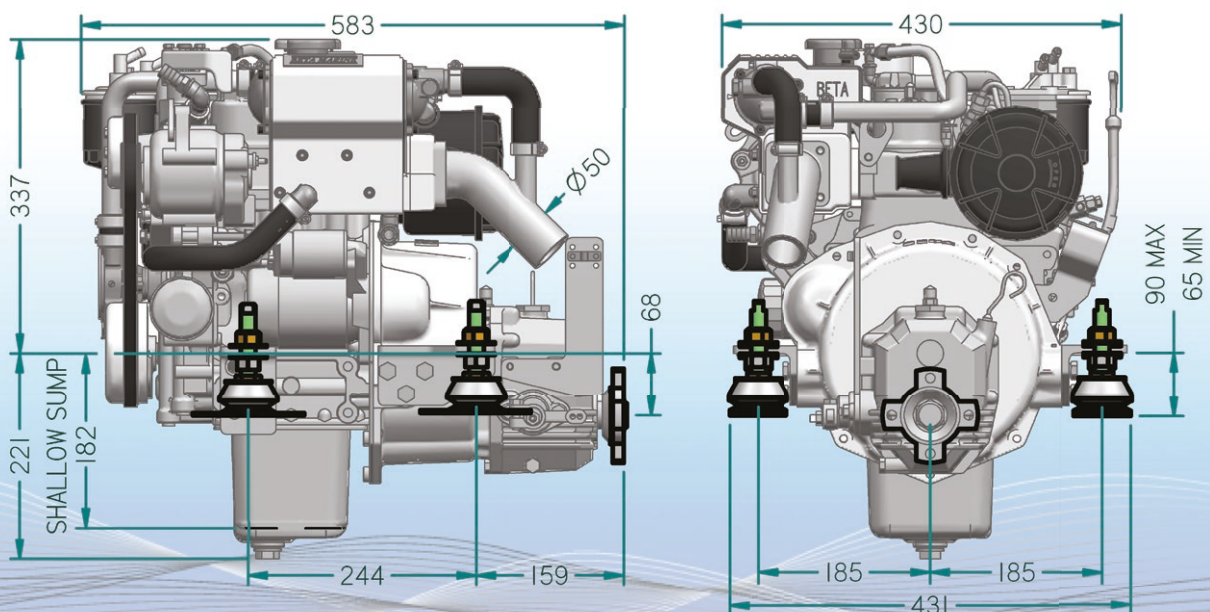

These are typical dimensions: visit our website for all engine / gearbox option drawings or contact Beta Marine direct

# Beta 14

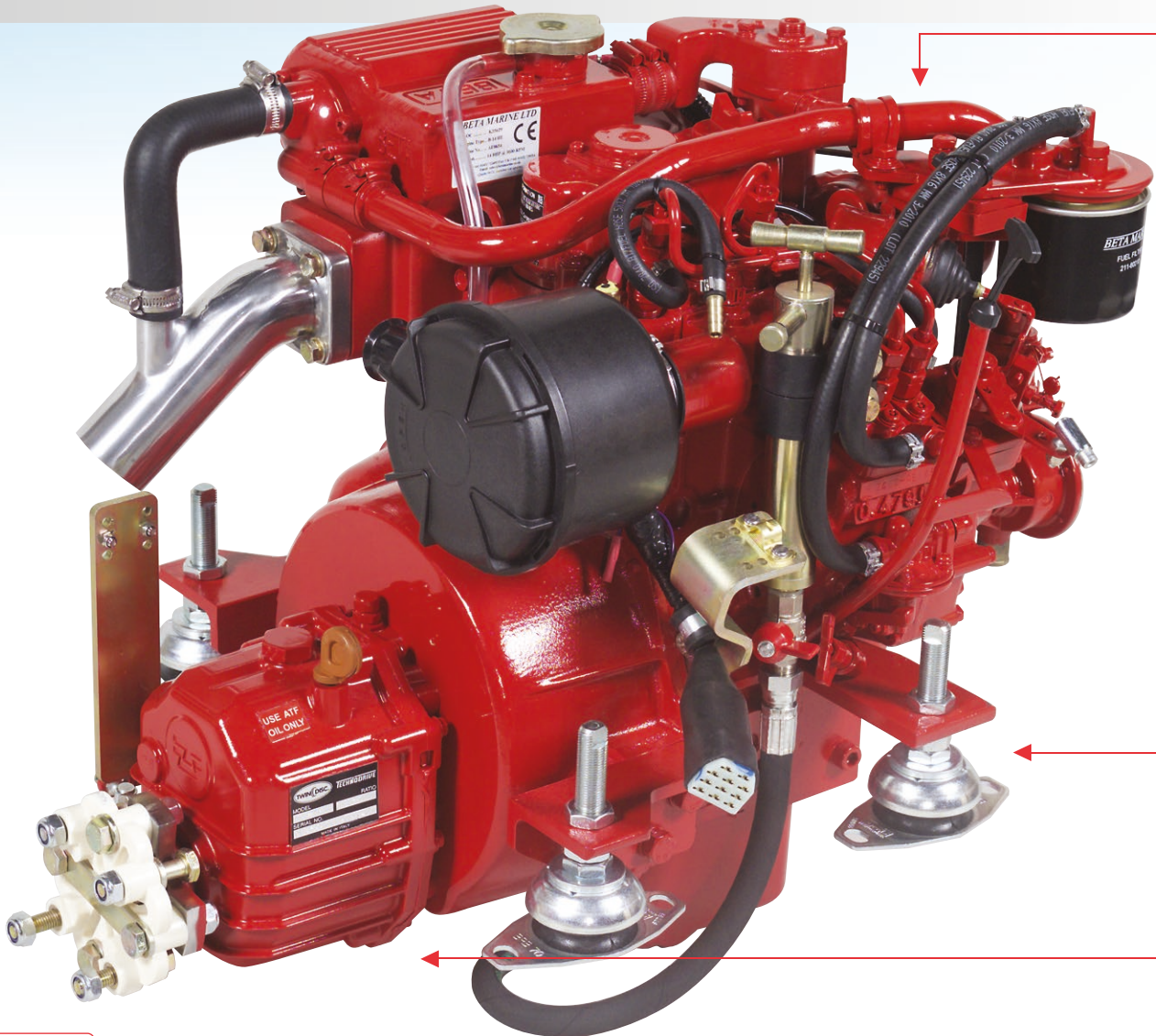

**BETA MARINE**  
**5**  
 YEAR 'SELF-SERVICE'  
 ENGINE WARRANTY

Recreational use only

## Kubota Base Engine

	<b>Cylinders</b>	2
	<b>Displacement</b>	479cc
	<b>Power</b>	13.5hp max @ 3,600rpm
	<b>Weight</b>	90Kg
	<b>Propeller</b>	AIA*

A general guidance for propeller size in inches, based upon 3 blade RH rotation and reduction ratio of 2:1. \*For accurate individual advice please provide us with your vessels current full specifications

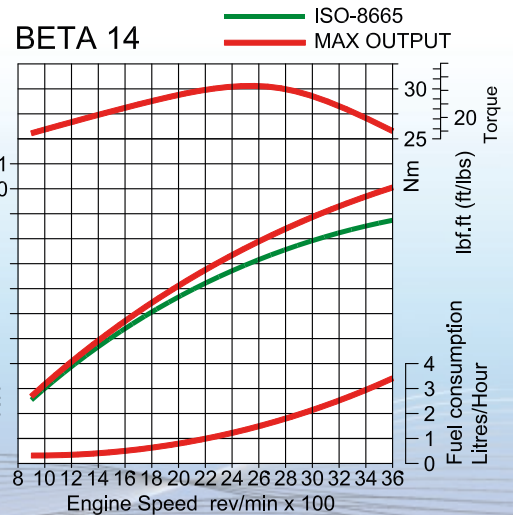

Based on theoretical propeller loading - matched at full speed



## Control Panel Options



A Panel	Opt.	C Deluxe Panel	Opt.
ABV Panel	Std.	CW Deluxe Panel	Opt.
ABVW Panel	Opt.	D Digital Panel	Opt.
B Panel	Opt.	Flybridge Control - Additional	
BW Panel	Opt.	C Panel & 6m Connection Cable	Opt.

## Electrical Options



40 Amp, 12 Volt Alternator	Std.	70 Amp, 12 Volt Insulated Return Alternator	Opt.
75 Amp, 12 Volt Alternator in Lieu of Standard	Opt.	125 Amp, 12 Volt Split Charging System	Opt.
120 Amp, 12 Volt Alternator in Lieu of Standard	Opt.		

## Gearbox Options



### Bobtail - No Gearbox

"Bobtail" Engine with Drive Plate and Housing Only Std.

### Technodrive / Twin Disc

TMC40 - Mechanical	Std.
TMC60 - Mechanical	Opt.
TMC60A - 7° Down Angle, Mechanical	Std.

### PRM Marine

PRM60 - Mechanical	Std.
PRM90 - Mechanical	Opt.
PRM150 - Hydraulic	Opt.

### ZF

ZF15MIV - 15° V Drive, Mechanical	Std.
-----------------------------------	------

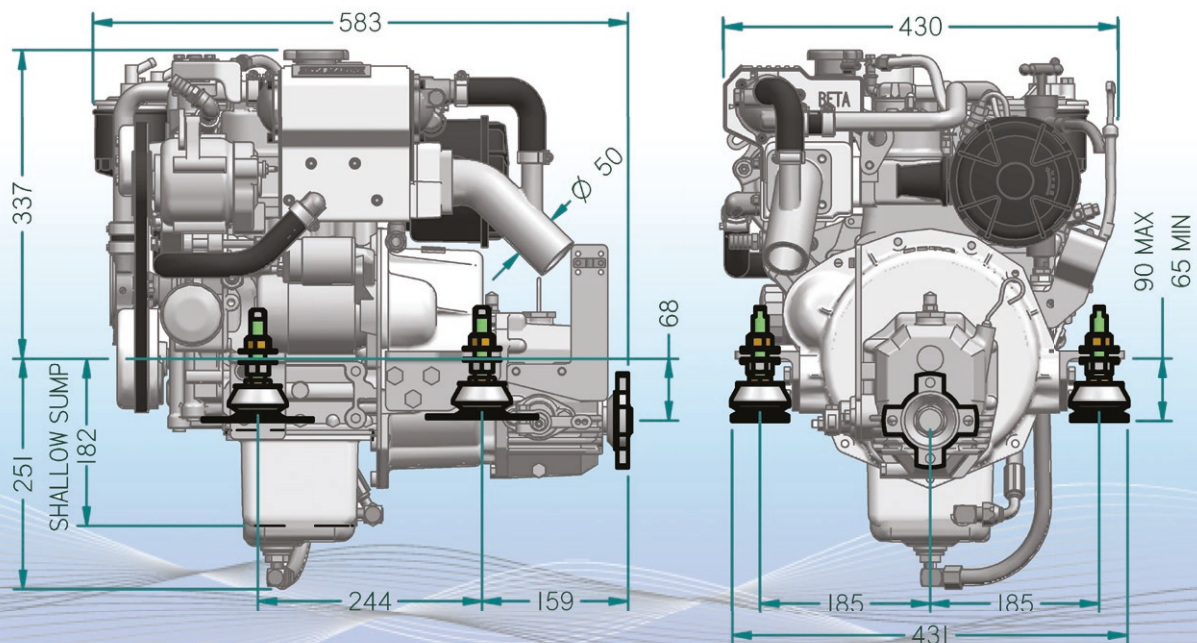

These are typical dimensions: visit our website for all engine / gearbox option drawings or contact Beta Marine direct

# Beta 16

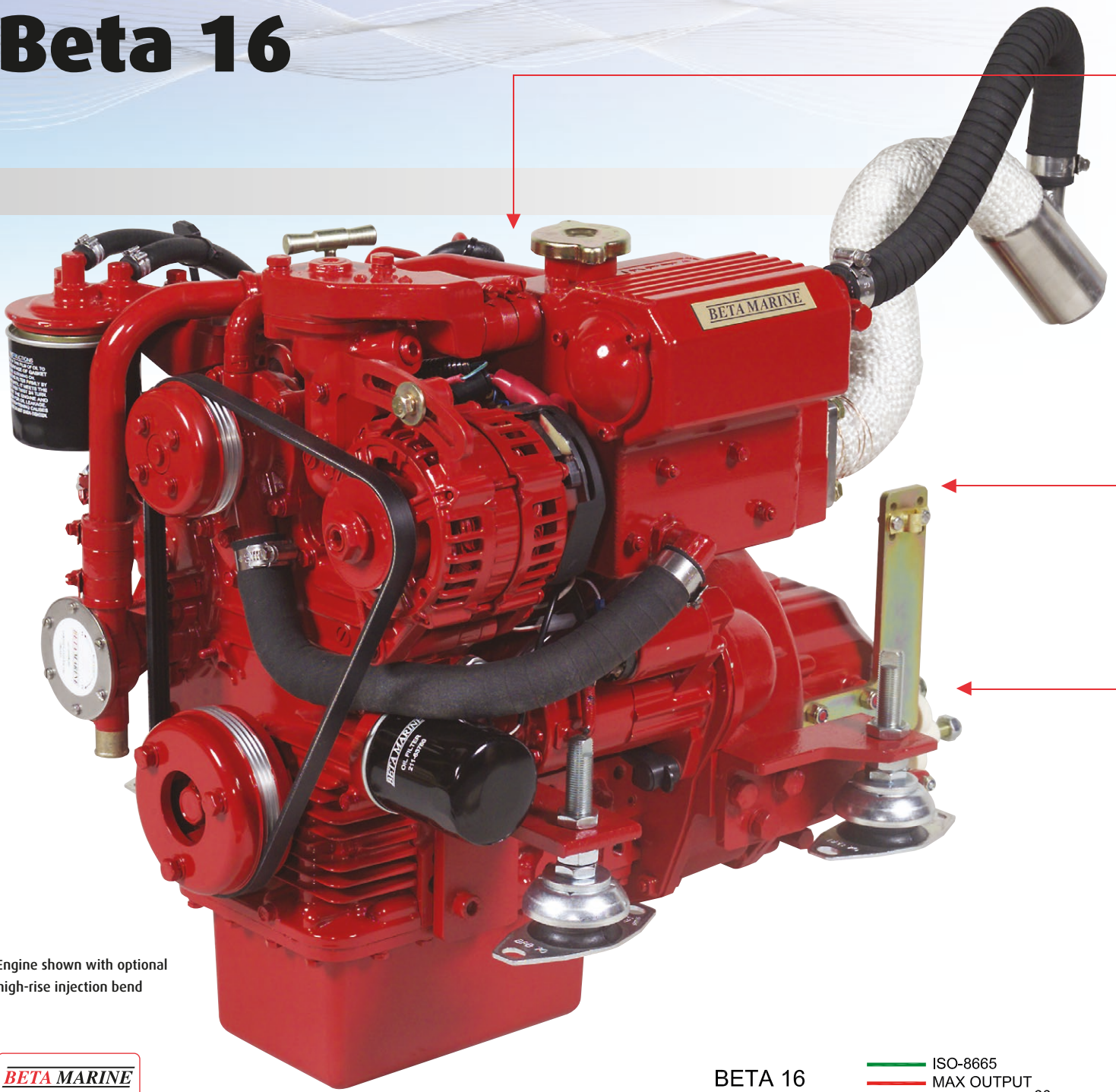

Engine shown with optional high-rise injection bend



Recreational use only

## Kubota Base Engine

	<b>Cylinders</b>	2
	<b>Displacement</b>	599cc
	<b>Power</b>	16hp max @ 3,600rpm
	<b>Weight</b>	95Kg
	<b>Propeller</b>	AIA*

A general guidance for propeller size in inches, based upon 3 blade RH rotation and reduction ratio of 2:1. \*For accurate individual advice please provide us with your vessels current full specifications

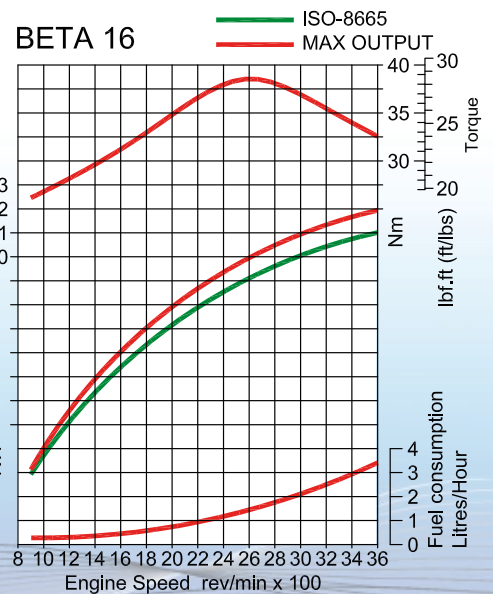

Based on theoretical propeller loading - matched at full speed



## Control Panel Options

A Panel	Opt.	C Deluxe Panel	Opt.
ABV Panel	Std.	CW Deluxe Panel	Opt.
ABVW Panel	Opt.	D Digital Panel	Opt.
B Panel	Opt.	Flybridge Control - Additional	
BW Panel	Opt.	C Panel & 6m Connection Cable	Opt.



## Electrical Options

40 Amp, 12 Volt Alternator	Std.	70 Amp, 12 Volt Insulated Return Alternator	Opt.
75 Amp, 12 Volt Alternator in Lieu of Standard	Opt.	125 Amp, 12 Volt Split Charging System	Opt.
120 Amp, 12 Volt Alternator in Lieu of Standard	Opt.		



## Gearbox Options

<b>Bobtail - No Gearbox</b>		<b>PRM Marine</b>	
"Bobtail" Engine with Drive Plate and Housing Only	Std.	PRM60 - Mechanical	Std.
		PRM90 - Mechanical	Opt.
		PRM150 - Hydraulic	Opt.
<b>Technodrive / Twin Disc</b>		<b>ZF</b>	
TMC40 - Mechanical	Std.	ZF15MIV - 15° V Drive, Mechanical	Std.
TMC60 - Mechanical	Opt.		
TMC60A - 7° Down Angle, Mechanical	Std.		

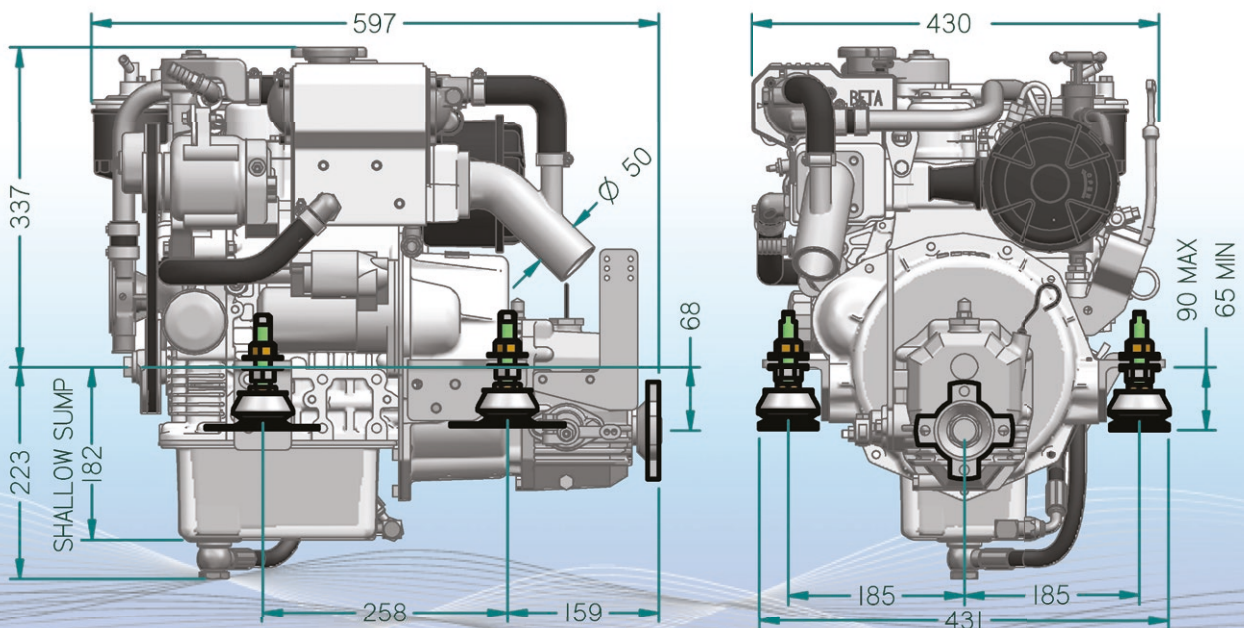

These are typical dimensions: visit our website for all engine / gearbox option drawings or contact Beta Marine direct

# Beta 20

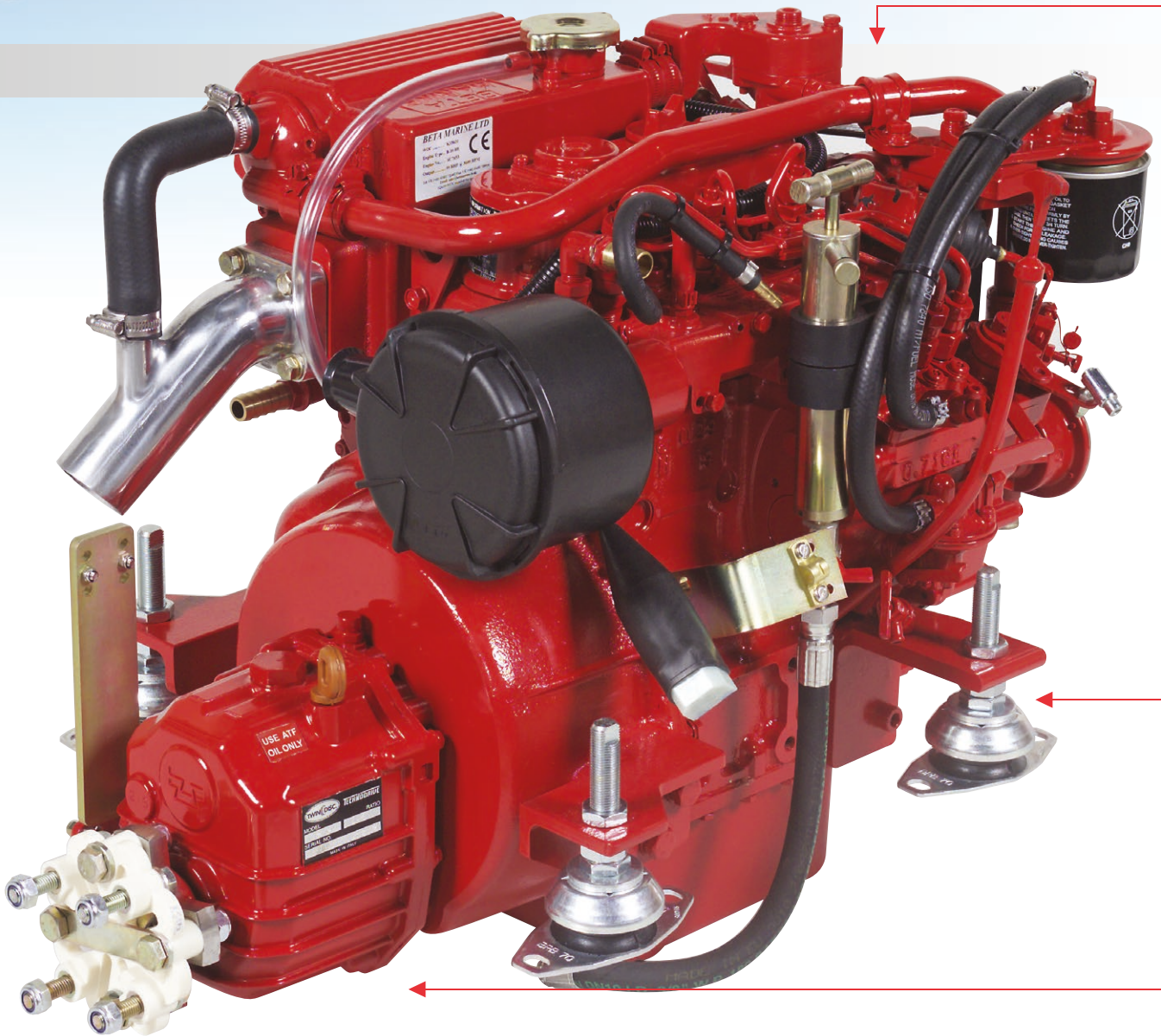





**BETA MARINE**

**5**

YEAR 'SELF-SERVICE'  
ENGINE WARRANTY

Recreational use only

## Kubota Base Engine

	<b>Cylinders</b>	<b>3</b>
	<b>Displacement</b>	<b>719cc</b>
	<b>Power</b>	<b>20hp max @ 3,600rpm</b>
	<b>Weight</b>	<b>104Kg</b>
	<b>Propeller</b>	<b>AIA*</b>

A general guidance for propeller size in inches, based upon 3 blade RH rotation and reduction ratio of 2:1. \*For accurate individual advice please provide us with your vessels current full specifications

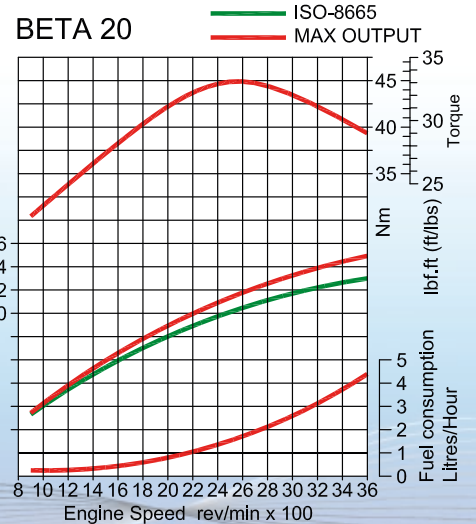

Based on theoretical propeller loading - matched at full speed

## Control Panel Options



A Panel	Opt.	C Deluxe Panel	Opt.
ABV Panel	Std.	CW Deluxe Panel	Opt.
ABVW Panel	Opt.	D Digital Panel	Opt.
B Panel	Opt.	Flybridge Control - Additional	
BW Panel	Opt.	C Panel & 6m Connection Cable	Opt.

## Electrical Options



40 Amp, 12 Volt Alternator	Std.	70 Amp, 12 Volt Insulated Return Alternator	Opt.
75 Amp, 12 Volt Alternator in Lieu of Standard	Opt.	125 Amp, 12 Volt Split Charging System	Opt.
120 Amp, 12 Volt Alternator in Lieu of Standard	Opt.		

## Gearbox Options



### Bobtail - No Gearbox

"Bobtail" Engine with Drive Plate and Housing Only Std.

### Technodrive / Twin Disc

TMC40 - Mechanical	Std.
TMC60 - Mechanical	Opt.
TMC60A - 7° Down Angle, Mechanical	Std.

### PRM Marine

PRM60 - Mechanical	Std.
PRM90 - Mechanical	Opt.
PRM150 - Hydraulic	Std.

### ZF

ZF15MIV - 15° V Drive, Mechanical	Std.
-----------------------------------	------

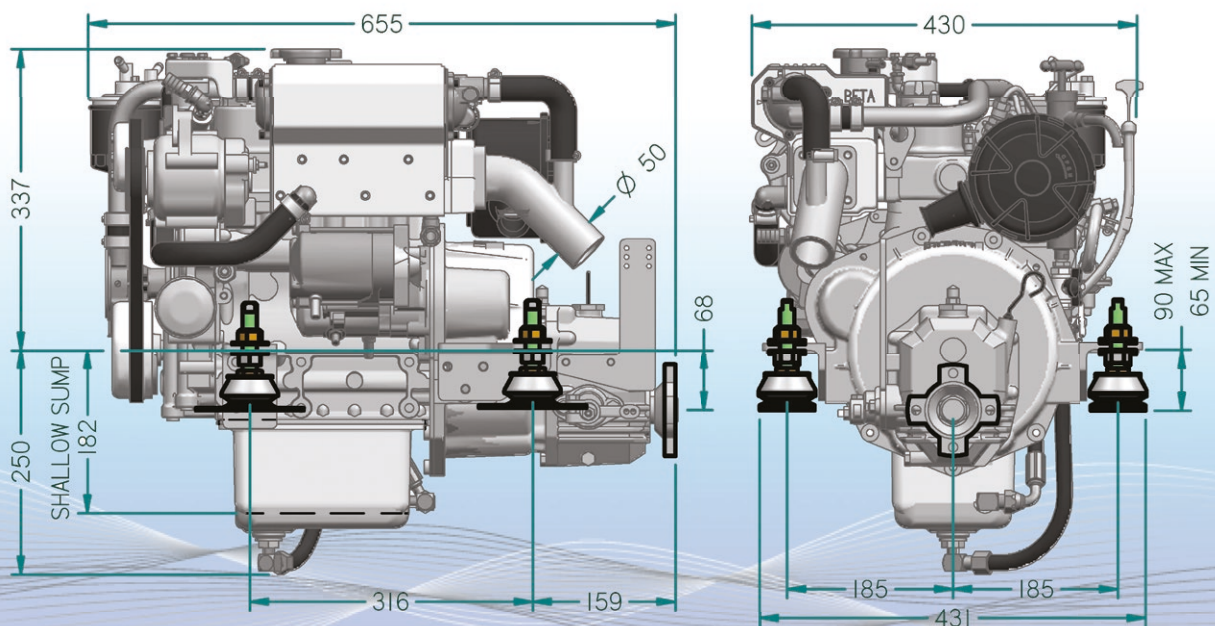

These are typical dimensions: visit our website for all engine / gearbox option drawings or contact Beta Marine direct



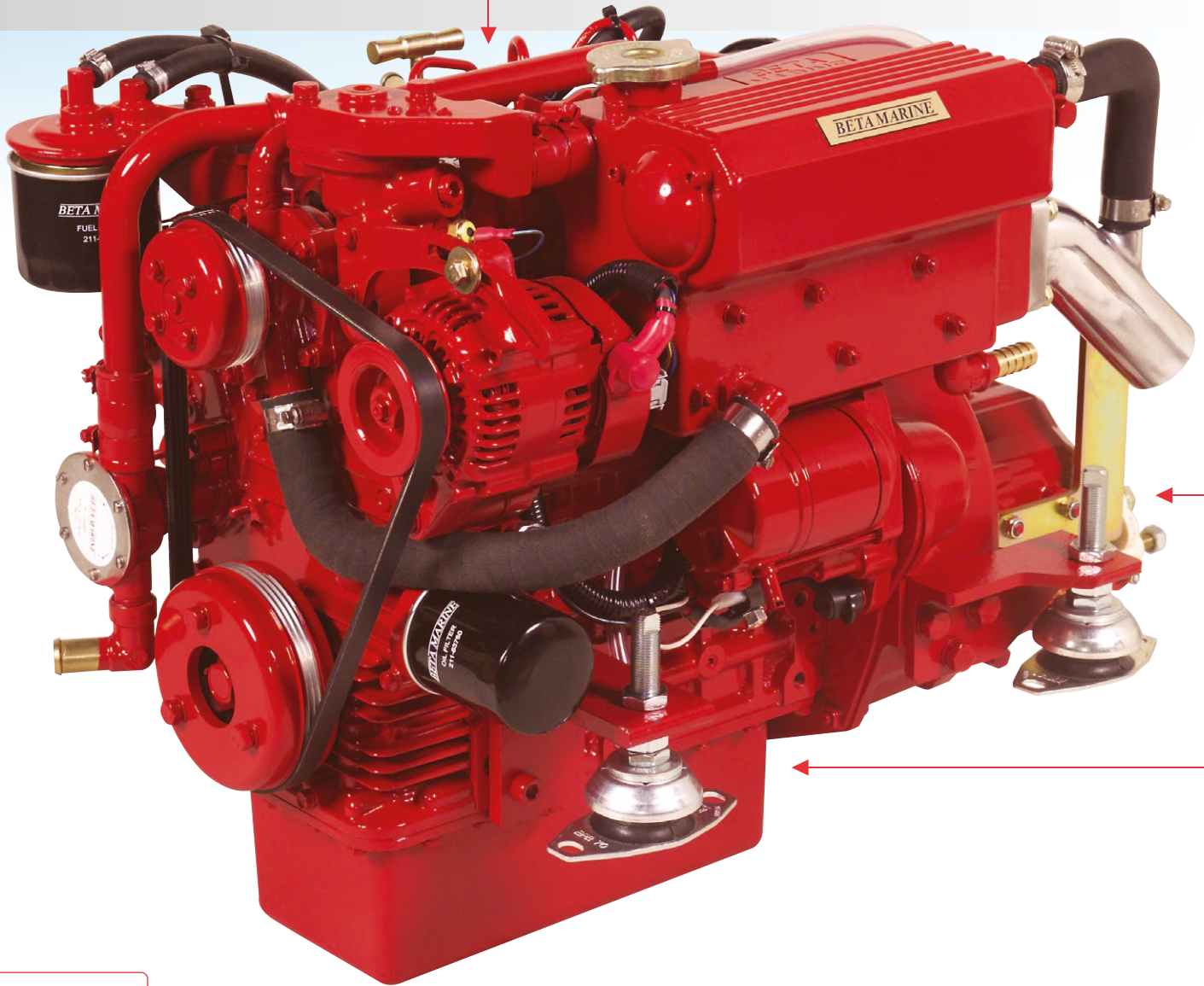

# Beta 25



**BETA MARINE**  
**5**  
 YEAR 'SELF-SERVICE'  
 ENGINE WARRANTY

Recreational use only

## Kubota Base Engine

	<b>Cylinders</b>	<b>3</b>
	<b>Displacement</b>	<b>898cc</b>
	<b>Power</b>	<b>25hp max @ 3,600rpm</b>
	<b>Weight</b>	<b>113Kg</b>
	<b>Propeller</b>	<b>AIA*</b>

A general guidance for propeller size in inches, based upon 3 blade RH rotation and reduction ratio of 2:1. \*For accurate individual advice please provide us with your vessels current full specifications

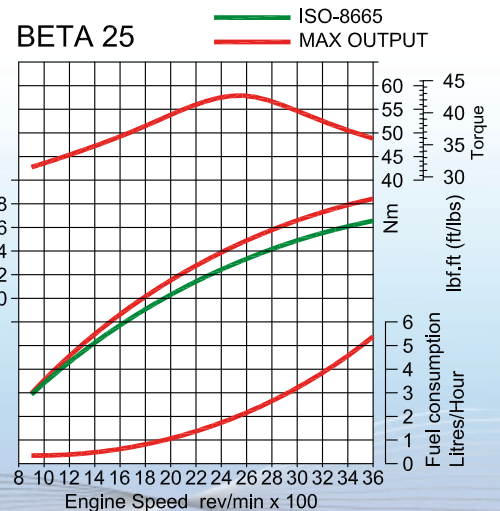

Based on theoretical propeller loading - matched at full speed

## Control Panel Options



A Panel	Opt.	C Deluxe Panel	Opt.
ABV Panel	Std.	CW Deluxe Panel	Opt.
ABVW Panel	Opt.	D Digital Panel	Opt.
B Panel	Opt.	Flybridge Control - Additional	
BW Panel	Opt.	C Panel & 6m Connection Cable	Opt.

## Electrical Options



40 Amp, 12 Volt Alternator	Std.	70 Amp, 12 Volt Insulated Return Alternator	Opt.
75 Amp, 12 Volt Alternator in Lieu of Standard	Opt.	125 Amp, 12 Volt Split Charging System	Opt.
120 Amp, 12 Volt Alternator in Lieu of Standard	Opt.		

## Gearbox Options



### Bobtail - No Gearbox

"Bobtail" Engine with Drive Plate and Housing Only Std.

### Technodrive / Twin Disc

TMC40 - Mechanical Std.  
 TMC60 - Mechanical Opt.  
 TMC60A - 7° Down Angle, Mechanical Std.

### PRM Marine

PRM60 - Mechanical Std.  
 PRM90 - Mechanical Opt.  
 PRM150 - Hydraulic Std.

### ZF

ZF15MIV - 15° V Drive, Mechanical Std.

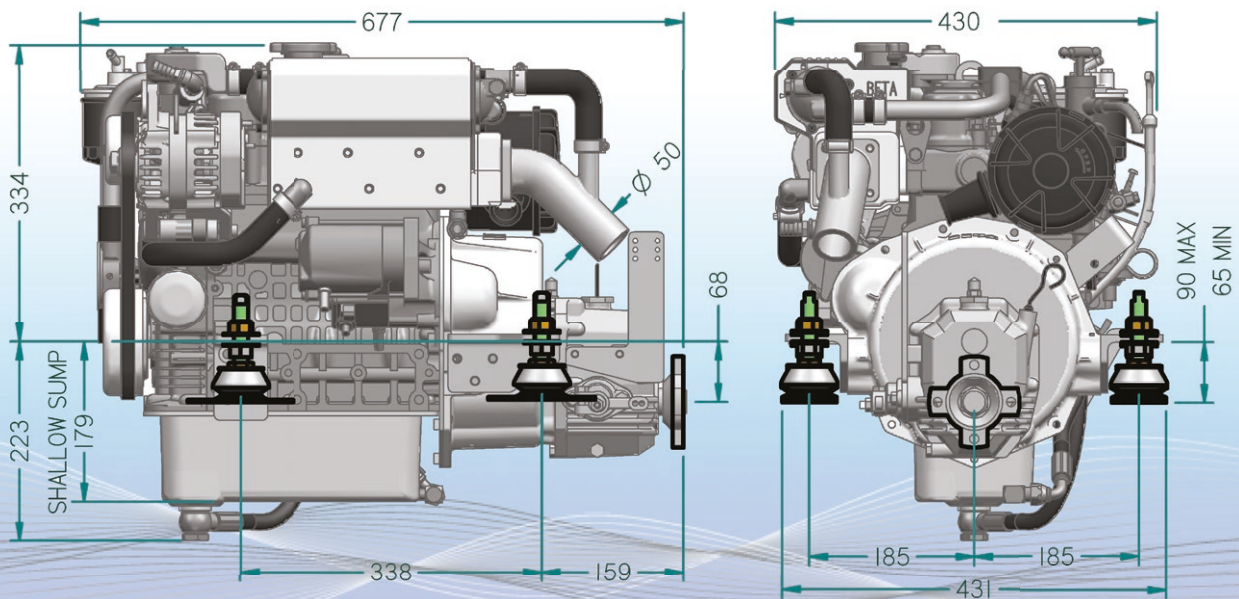

These are typical dimensions: visit our website for all engine / gearbox option drawings or contact Beta Marine direct





# Beta 30



**BETA MARINE**  
**5**  
 YEAR 'SELF-SERVICE'  
 ENGINE WARRANTY

Recreational use only

## Kubota Base Engine

	<b>Cylinders</b>	<b>3</b>
	<b>Displacement</b>	<b>1123cc</b>
	<b>Power</b>	<b>30hp max @ 3,600rpm</b>
	<b>Weight</b>	<b>139Kg</b>
	<b>Propeller</b>	<b>AIA*</b>

A general guidance for propeller size in inches, based upon 3 blade RH rotation and reduction ratio of 2:1. \*For accurate individual advice please provide us with your vessels current full specifications

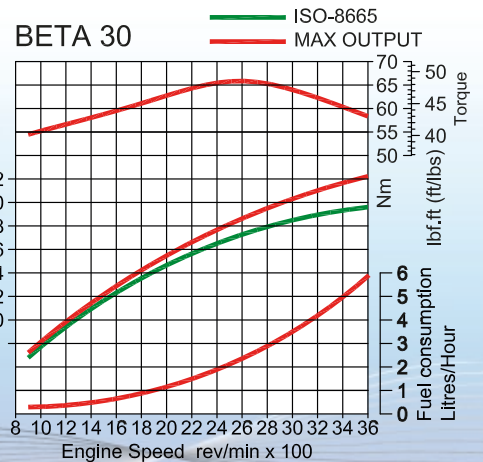

Based on theoretical propeller loading - matched at full speed



## Control Panel Options



A Panel	Opt.	C Deluxe Panel	Opt.
ABV Panel	Std.	CW Deluxe Panel	Opt.
ABVW Panel	Opt.	D Digital Panel	Opt.
B Panel	Opt.	Flybridge Control - Additional	
BW Panel	Opt.	C Panel & 6m Connection Cable	Opt.

## Electrical Options



70 Amp, 12 Volt Alternator	Std.	120 Amp, 12 Volt Secondary Domestic Alternator	Opt.
120 Amp, 12 Volt Alternator in Lieu of Standard	Opt.	125 Amp, 12 Volt Split Charging System	Opt.
70 Amp, 12 Volt Insulated Return Alternator	Opt.		

## Gearbox Options



### Bobtail - No Gearbox

"Bobtail" Engine with Drive Plate and Housing Only Std.

### Technodrive / Twin Disc

TMC40 - Mechanical Std.

TMC60 - Mechanical Opt.

TMC60A - 7° Down Angle, Mechanical Std.

### PRM Marine

PRM90 - Mechanical Std.

PRM125 - Mechanical Opt.

PRM150 - Hydraulic Std.

PRM280 - Hydraulic Opt.

PRM260C - In-line Hydraulic Opt.

### ZF

ZF15MIV - 15° V Drive, Mechanical Std.

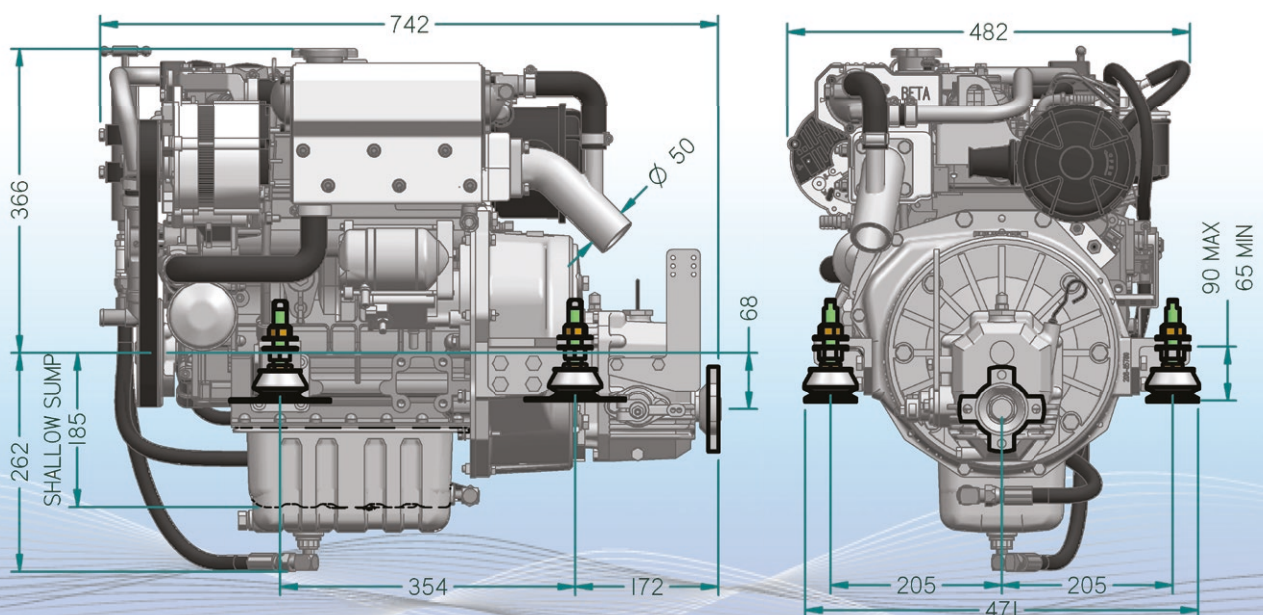

These are typical dimensions: visit our website for all engine / gearbox option drawings or contact Beta Marine direct





# Beta 35



**BETA MARINE**  
**5**  
 YEAR 'SELF-SERVICE'  
 ENGINE WARRANTY

Recreational use only

## Kubota Base Engine

	<b>Cylinders</b>	4
	<b>Displacement</b>	1498cc
	<b>Power</b>	35hp max @ 2,800rpm
	<b>Weight</b>	168Kg
	<b>Propeller</b>	AIA*

A general guidance for propeller size in inches, based upon 3 blade RH rotation and reduction ratio of 2:1. \*For accurate individual advice please provide us with your vessels current full specifications

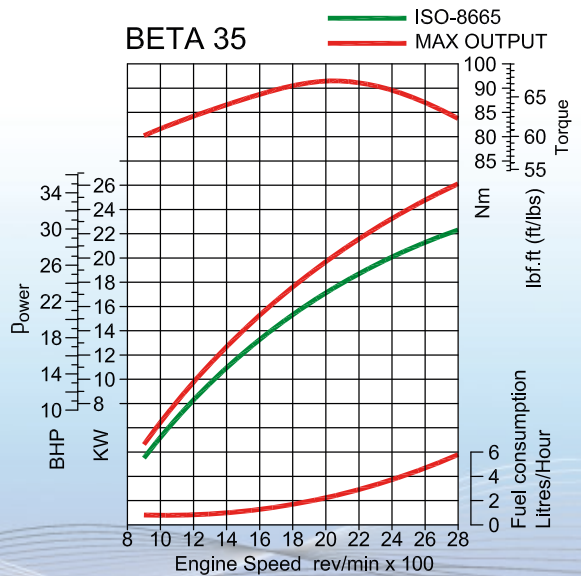

Based on theoretical propeller loading - matched at full speed

## Control Panel Options



A Panel	Opt.	C Deluxe Panel	Opt.
ABV Panel	Std.	CW Deluxe Panel	Opt.
ABVW Panel	Opt.	D Digital Panel	Opt.
B Panel	Opt.	Flybridge Control - Additional	
BW Panel	Opt.	C Panel & 6m Connection Cable	Opt.

## Electrical Options



70 Amp, 12 Volt Alternator	Std.	120 Amp, 12 Volt Secondary Domestic Alternator	Opt.
120 Amp, 12 Volt Alternator in Lieu of Standard	Opt.	125 Amp, 12 Volt Split Charging System	Opt.
70 Amp, 12 Volt Insulated Return Alternator	Opt.	3.5 kVA Travel Power - 230 Volt, Single Phase 50Hz	Opt.

## Gearbox Options



### Bobtail - No Gearbox

"Bobtail" Engine with Drive Plate and Housing Only **Std.**

### Technodrive / Twin Disc

TMC60 - Mechanical **Std.**

TMC60A - 7° Down Angle, Mechanical **Std.**

### PRM Marine

PRM125 - Mechanical **Std.**

PRM150 - Hydraulic **Std.**

PRM280 - Hydraulic **Opt.**

PRM260C - In-line Hydraulic **Opt.**

### ZF

ZF15MIV - 15° V Drive, Mechanical **Std.**

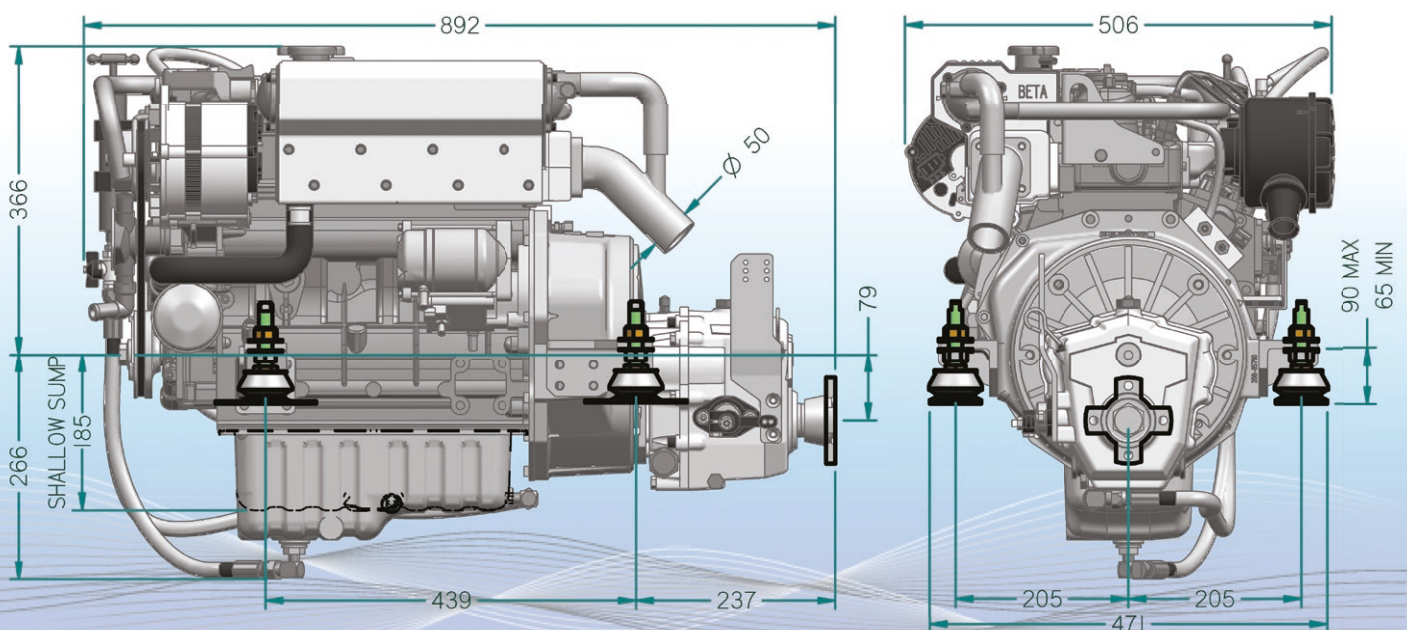

These are typical dimensions: visit our website for all engine / gearbox option drawings or contact Beta Marine direct

# Beta 38

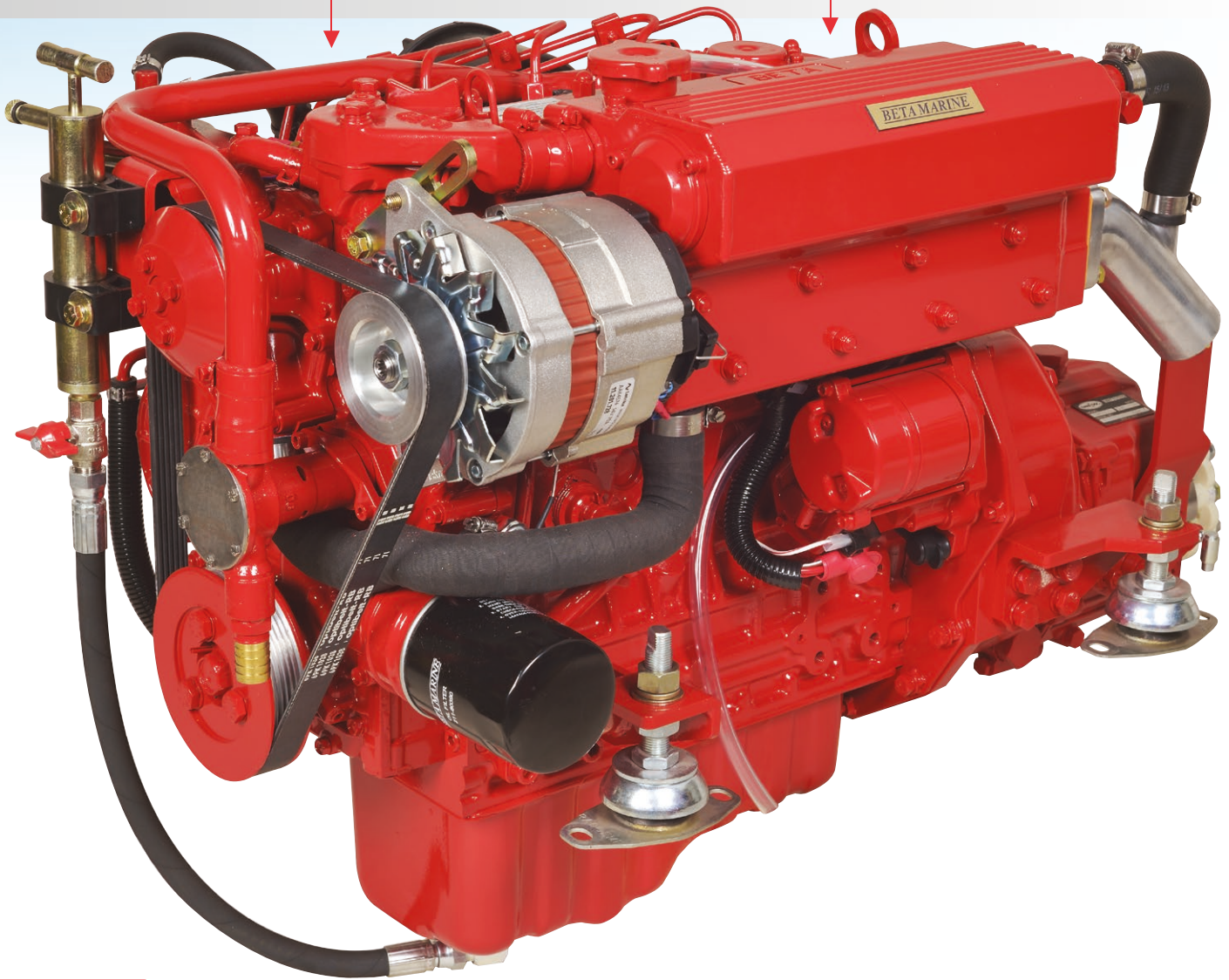





**BETA MARINE**

**5**

YEAR 'SELF-SERVICE' ENGINE WARRANTY

Recreational use only

## Kubota Base Engine

	<b>Cylinders</b>	4
	<b>Displacement</b>	1498cc
	<b>Power</b>	38hp max @ 3,600rpm
	<b>Weight</b>	168Kg
	<b>Propeller</b>	AIA*

A general guidance for propeller size in inches, based upon 3 blade RH rotation and reduction ratio of 2:1. \*For accurate individual advice please provide us with your vessels current full specifications

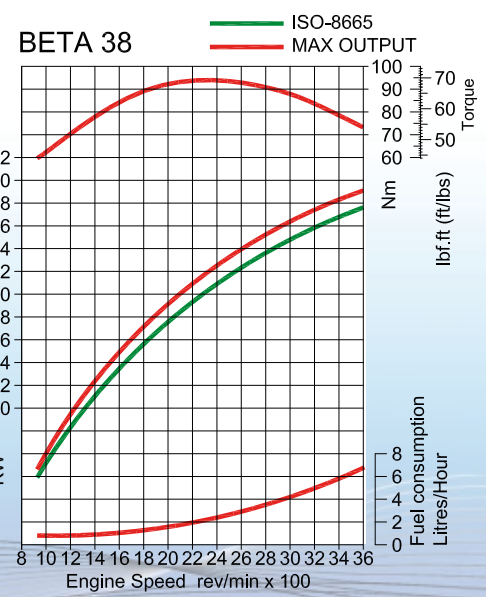

Based on theoretical propeller loading - matched at full speed

## Control Panel Options



A Panel	Opt.	C Deluxe Panel	Opt.
ABV Panel	Std.	CW Deluxe Panel	Opt.
ABVW Panel	Opt.	D Digital Panel	Opt.
B Panel	Opt.	Flybridge Control - Additional	
BW Panel	Opt.	C Panel & 6m Connection Cable	Opt.

## Electrical Options



70 Amp, 12 Volt Alternator	Std.	120 Amp, 12 Volt Secondary Domestic Alternator	Opt.
120 Amp, 12 Volt Alternator in Lieu of Standard	Opt.	125 Amp, 12 Volt Split Charging System	Opt.
70 Amp, 12 Volt Insulated Return Alternator	Opt.	3.5 kVA Travel Power - 230 Volt, Single Phase 50Hz	Opt.

## Gearbox Options



### Bobtail - No Gearbox

"Bobtail" Engine with Drive Plate and Housing Only **Std.**

### Technodrive / Twin Disc

TMC60 - Mechanical **Std.**

TMC60A - 7° Down Angle, Mechanical **Std.**

### PRM Marine

PRM125 - Mechanical **Std.**

PRM150 - Hydraulic **Std.**

PRM280 - Hydraulic **Opt.**

PRM260C - In-line Hydraulic **Opt.**

### ZF

ZF15MIV - 15° V Drive, Mechanical **Std.**

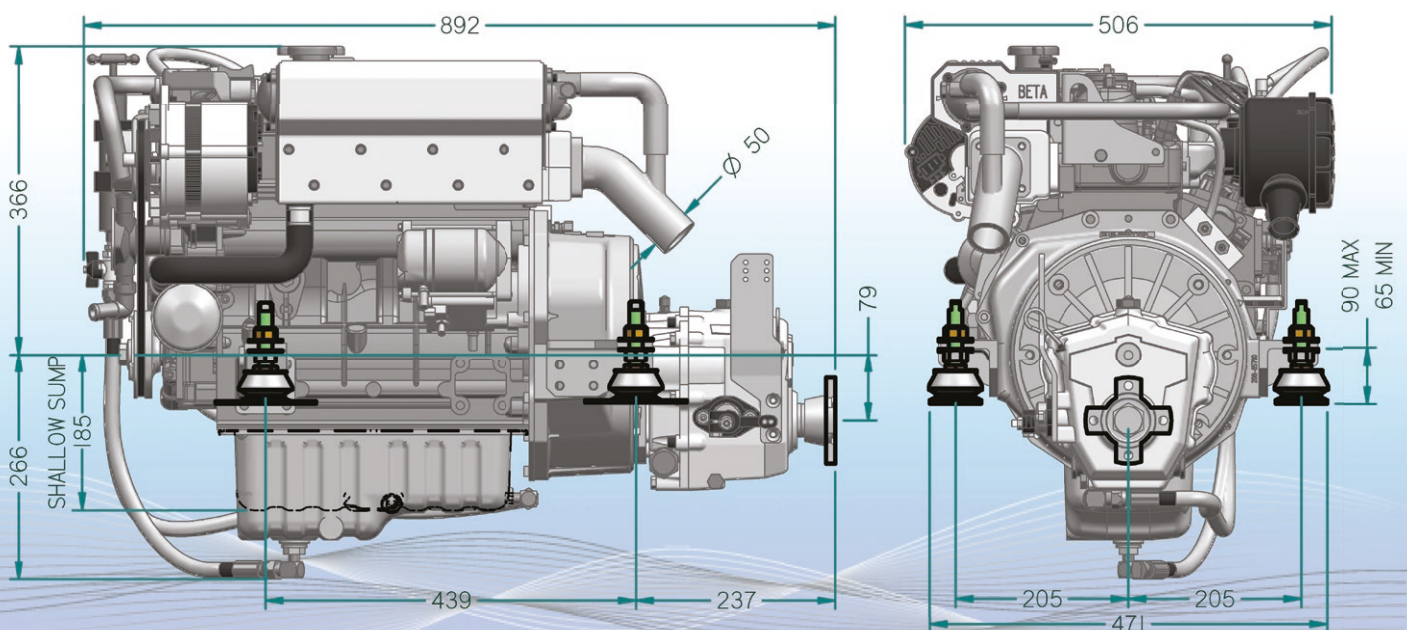

These are typical dimensions: visit our website for all engine / gearbox option drawings or contact Beta Marine direct

# Beta 45T

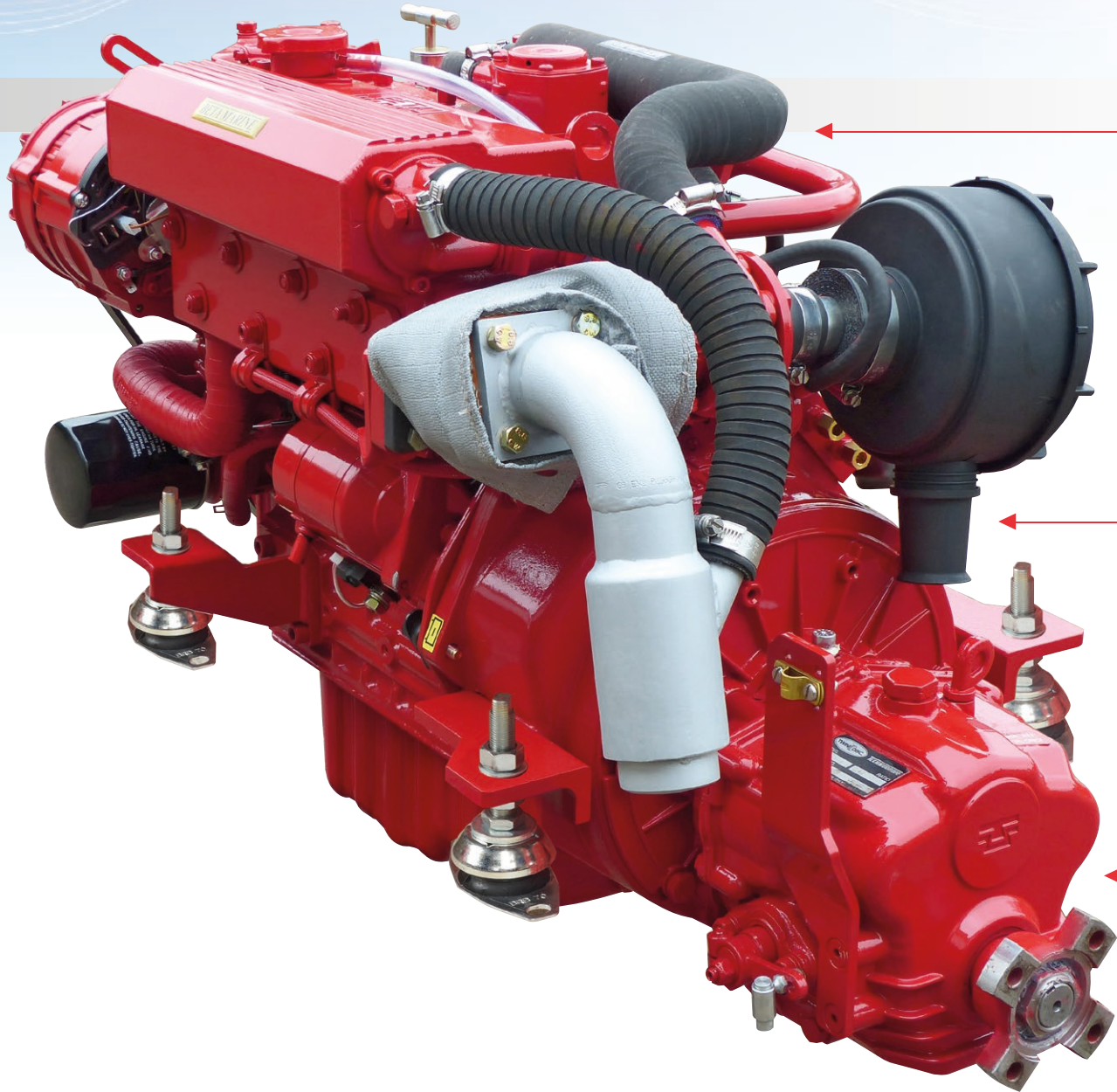





**BETA MARINE**

**5**

YEAR 'SELF-SERVICE'  
ENGINE WARRANTY

Recreational use only

## Kubota Base Engine

	<b>Cylinders</b>	<b>4</b>
	<b>Displacement</b>	<b>1498cc</b>
	<b>Power</b>	<b>45hp max @ 3,000rpm</b>
	<b>Weight</b>	<b>175Kg</b>
	<b>Propeller</b>	<b>AIA*</b>

A general guidance for propeller size in inches, based upon 3 blade RH rotation and reduction ratio of 2:1. \*For accurate individual advice please provide us with your vessels current full specifications

BETA 45T

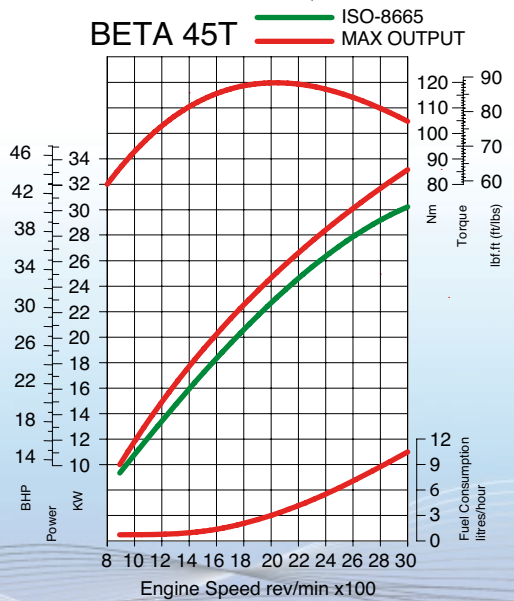

Based on theoretical propeller loading - matched at full speed

## Control Panel Options



A Panel	Opt.	C Deluxe Panel	Opt.
ABV Panel	Std.	CW Deluxe Panel	Opt.
ABVW Panel	Opt.	D Digital Panel	Opt.
B Panel	Opt.	Flybridge Control - Additional	
BW Panel	Opt.	C Panel & 6m Connection Cable	Opt.

## Electrical Options



70 Amp, 12 Volt Alternator	Std.	120 Amp, 12 Volt Secondary Domestic Alternator	Opt.
120 Amp, 12 Volt Alternator in Lieu of Standard	Opt.	125 Amp, 12 Volt Split Charging System	Opt.
70 Amp, 12 Volt Insulated Return Alternator	Opt.	3.5 kVA Travel Power - 230 Volt, Single Phase 50Hz	Opt.

## Gearbox Options



<b>Bobtail - No Gearbox</b>		<b>PRM Marine</b>	
"Bobtail" Engine with Drive Plate and Housing Only	Std.	PRM150 - Hydraulic	Std.
<b>Technodrive / Twin Disc</b>		PRM280 - Hydraulic	Opt.
TMC60 - Mechanical	Std.	PRM260C - In-line Hydraulic	Opt.
TMC60A - 7° Down Angle, Mechanical	Std.	<b>ZF</b>	
		ZF15MIV - 15° V Drive, Mechanical	Std.

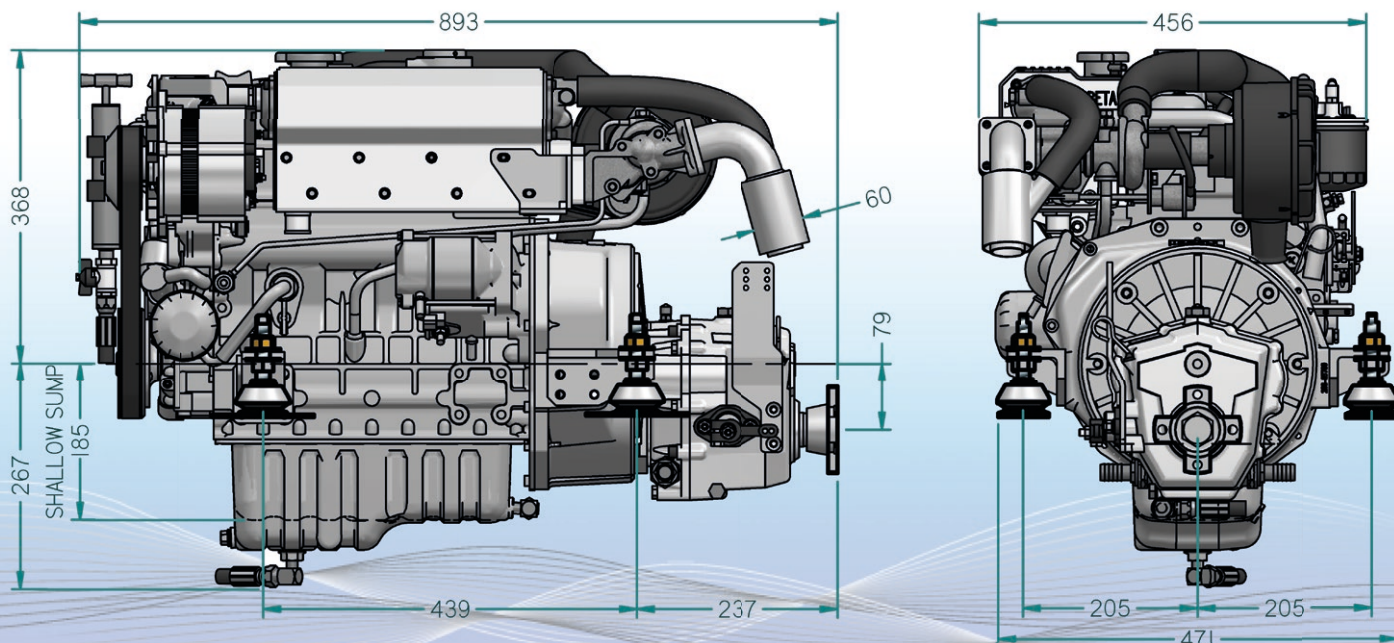

These are typical dimensions: visit our website for all engine / gearbox option drawings or contact Beta Marine direct

## Control Panels

### Standard Control Panel 'A' for Beta 10

Is key switch controlled for engine preheat & start, push button controlled for engine stop, has a green light indicator for 'power on', red warning light indicators & audible alarm for low oil pressure, high water temperature and engine alternator not charging. Complete with 3m\* of interconnection cable and multi pin plug connector.



### Standard Control Panel 'ABV' for Beta 14, 16, 20, 25, 30, 35, 38 & 45T

#### Optional for Beta 10

Is key switch controlled for engine preheat & start, push button controlled for engine stop, has a tachometer with running hour recorder, green light indicator for 'power on', red warning light indicators & audible alarm for low oil pressure, high water temperature and engine alternator not charging. Complete with 3m\* of interconnection cable and multi pin plug connector.



#### Optional Control Panel 'ABVW'

Is push button controlled for engine preheat, start & stop, has a tachometer with running hour recorder, green light indicator for 'power on', red warning light indicators & audible alarm for low oil pressure, high water temperature and engine alternator not charging. Complete with 3m\* of interconnection cable and multi pin plug connector.



#### Optional Control Panel 'B'

Is key switch controlled for engine preheat & start, push button controlled for engine stop, has a tachometer with running hour recorder and a water temperature gauge. Green light indicator for 'power on', red warning light indicators & audible alarm for low oil pressure, high water temperature and engine alternator not charging. Complete with 3m\* of interconnection cable and multi pin plug connector.



\*Extension looms are available, please refer to our relevant price list



## Optional Control Panel 'BW'

Is push button controlled for engine preheat, start & stop, has a tachometer with running hour recorder and a water temperature gauge. Green light indicator for 'power on', red warning light indicators & audible alarm for low oil pressure, high water temperature and engine alternator not charging. Complete with 3m\* of interconnection cable and multi pin plug connector.



## Optional Control Panel 'C' Deluxe

Is key switch controlled for engine preheat & start, push button controlled for engine stop, has a tachometer with running hour recorder, oil pressure, voltmeter & water temperature gauges. Green light indicator for 'power on', red warning light indicators & audible alarm for low oil pressure, high water temperature, engine and or domestic alternators not charging. Complete with 3m\* of interconnection cable and multi pin plug connector. Recommended option, when specifying an engine with both starter battery & domestic charge alternators.



## Optional Control Panel 'CW' Deluxe

Is push button controlled for engine preheat & start, push button controlled for engine stop, has a tachometer with running hour recorder, oil pressure, voltmeter & water temperature gauges. Green light indicator for 'power on', red warning light indicators & audible alarm for low oil pressure, high water temperature, engine and or domestic alternators not charging. Complete with 3m\* of interconnection cable and multi pin plug connector. Recommended option, when specifying an engine with both starter battery & domestic charge alternators.



## Control Panels

### Optional 'Flybridge Control'

Comprises of a C Deluxe panel with 3m\* of interconnection cable with multi pin plug and either a standard ABV panel or chosen optional panel complete with 6m\* of interconnection cable and multi pin plug connector for the Flybridge.



### Optional 'C/CW' - NMEA 2000 Module

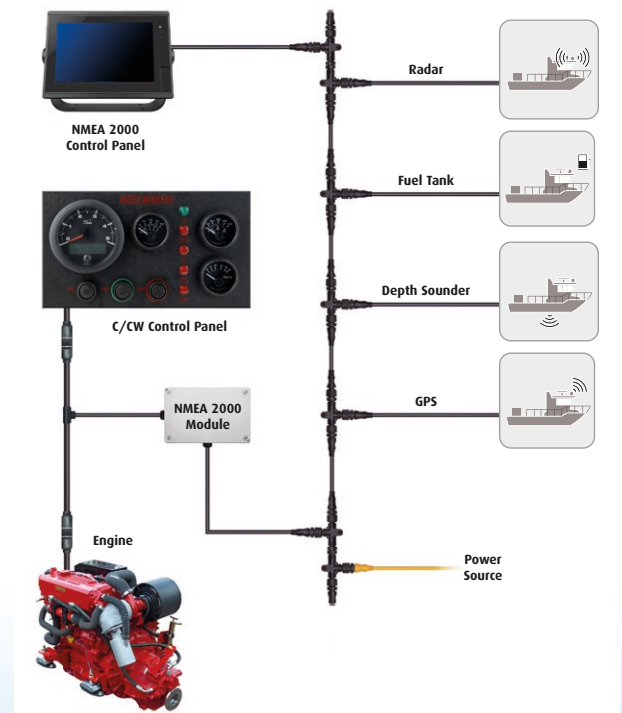

Beta Marine & Actisense have developed an interconnection module to facilitate an interface that will connect a Beta Marine C or CW engine control panel with an NMEA 2000 network. This module simply "T" connects between an engine and engine control panel & converts information to a NMEA 2000 network friendly format.

Which enables you to digitally monitor engine RPM, engine temperature, oil pressure or voltmeter reading from your NMEA 2000 control panel.

The interconnection module uses a standard Micro-C connection to allow data to be relayed and viewed all across your NMEA 2000 on-board network.

On vessels with twin engine installations it is possible to re-configure your NMEA 2000 network software to facilitate dual or independent viewing on network devices.

## Optional Control Panel 'D' Digital

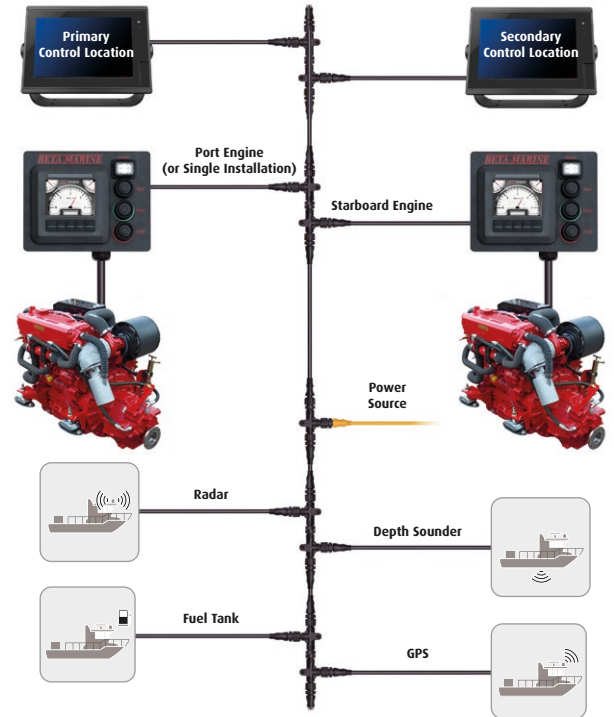

Our most technically advanced engine control/monitor whose module is water resistant to IP67 and has a super bright screen that facilitates viewing in both strong sunlight and also at night, simply select the appropriate setting to ensure that it is always easy on the eye.

As well as controlling the engine for preheat, start & stop at the press of a button it also allows you to digitally monitor engine RPM, engine temperature, oil pressure and provides a voltmeter for either single or twin alternator.

The panel uses standard Micro-C connection which allows data to be relayed and viewed all across your on-board network. It is compatible with NMEA 2000 & IEC 61 162-3. On vessels with twin engine installations each engine control panel needs to be programmed as Port and Starboard to facilitate dual or independent viewing on other network devices.

Complete with 3m\* of interconnection cable and multi pin plug connector.

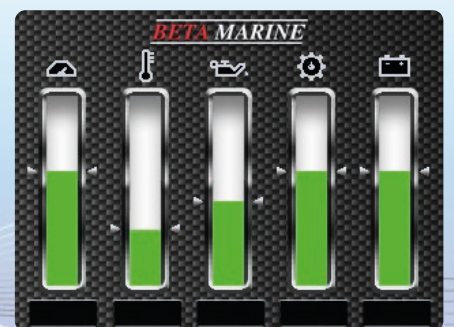

\*Extension looms are available, please refer to our relevant price list

## Electrical & Installation Options



### Standard Drive Belt Set Up

Beta 10, 14, 16, 20 & 25 engines are equipped with a standard 40 amp alternator, Beta 30, 35, 38 & 45 engines are equipped with a standard 70 amp alternator all driven by a polyvee belt/pulley drive.

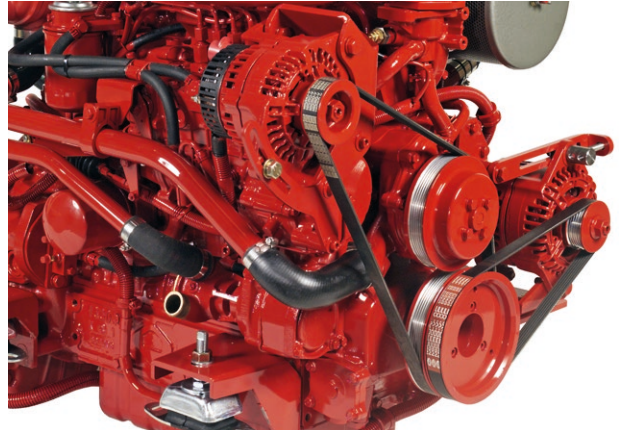

### Secondary Alternators

Are available dependent on engine model, where appropriate polyvee belt/pulley drive will be included; please refer to the tables within the individual engine model pages.



3.5/5kVA  
Travel Power

### Optional Travel Power 3.5 or 5 kVA

The engine mounted generator & bulkhead mounted inverter are very compact in size but produce either 3.5 or 5kVA mains electricity at 230 volts, single phase and 50 Hz just above engine tick over, achieving full output at approximately 1500 RPM or typical "normal" cruising speed. Providing ample power for most on board domestic electrical requirements. Complete with 5m shielded cable to run to the power control box and an option for a remote control switch.

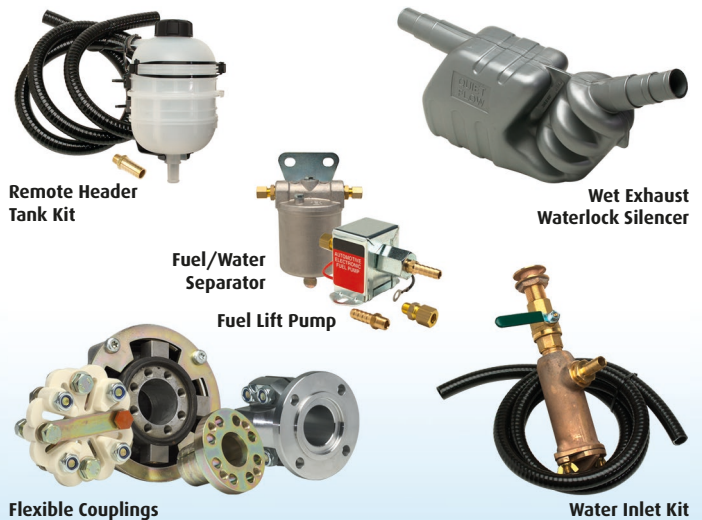

Remote Header  
Tank Kit

Fuel/Water  
Separator

Fuel Lift Pump

Wet Exhaust  
Waterlock Silencer

Flexible Couplings

Water Inlet Kit

### Optional Installation Accessories

Beta Marine offer a comprehensive range of accessories to support your installation with solutions available to cover all needs; engine, gearbox, propeller shaft connection, fresh & seawater management, additional or remote, lubrication, filtration, dry or wet exhaust components & for the engine bay. For comprehensive options please refer to relevant price list.

## 3D Computer Aided Design

Beta Marine has continually and heavily, invested in state of the art 3D CAD software to ensure we are best placed to design, develop, stress test & create tooling to manufacture new products once they have successfully completed sea trials.

Additionally this investment has given us capacity to offer additional bespoke design services for both propulsion engines & generating sets to our customers, whether the need is recreational or for commercial offshore use.

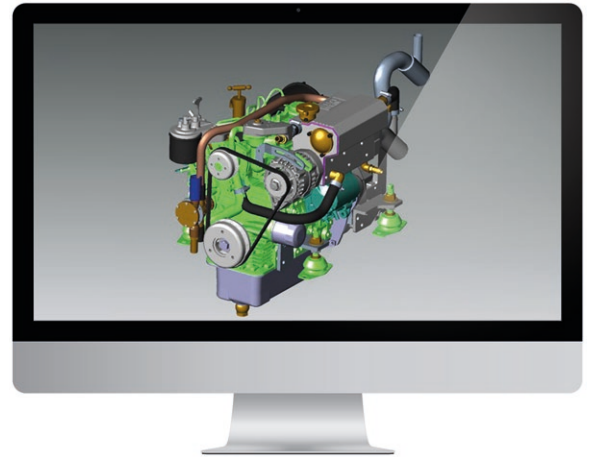

## Optional Hydraulic Pump Solutions

Beta Marine can design, manufacture, supply and install clutched or continuous running hydraulic pumps for deck washing, net trawling etc. Or we can design, manufacture and install a bespoke pump free issued by a customer.

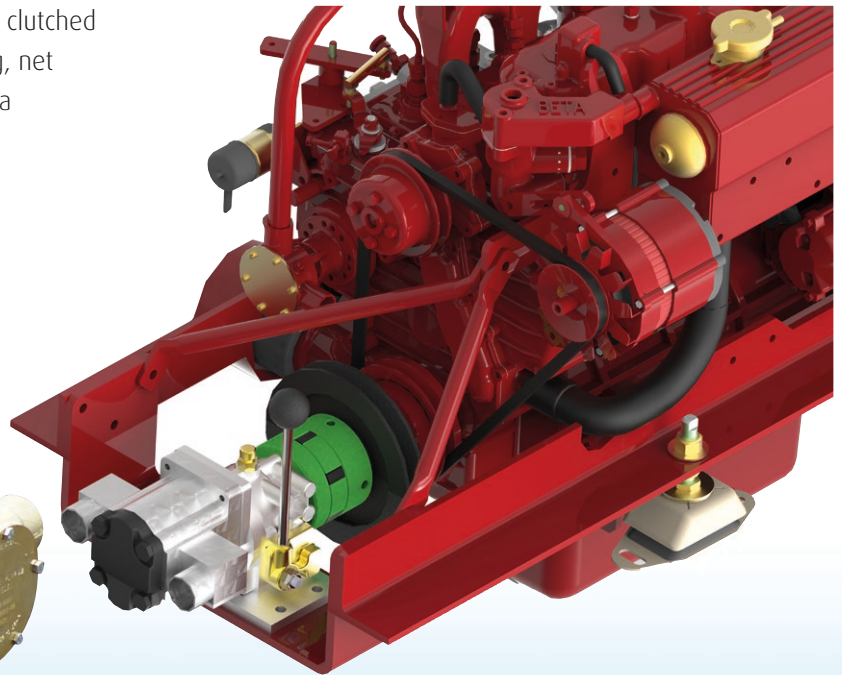
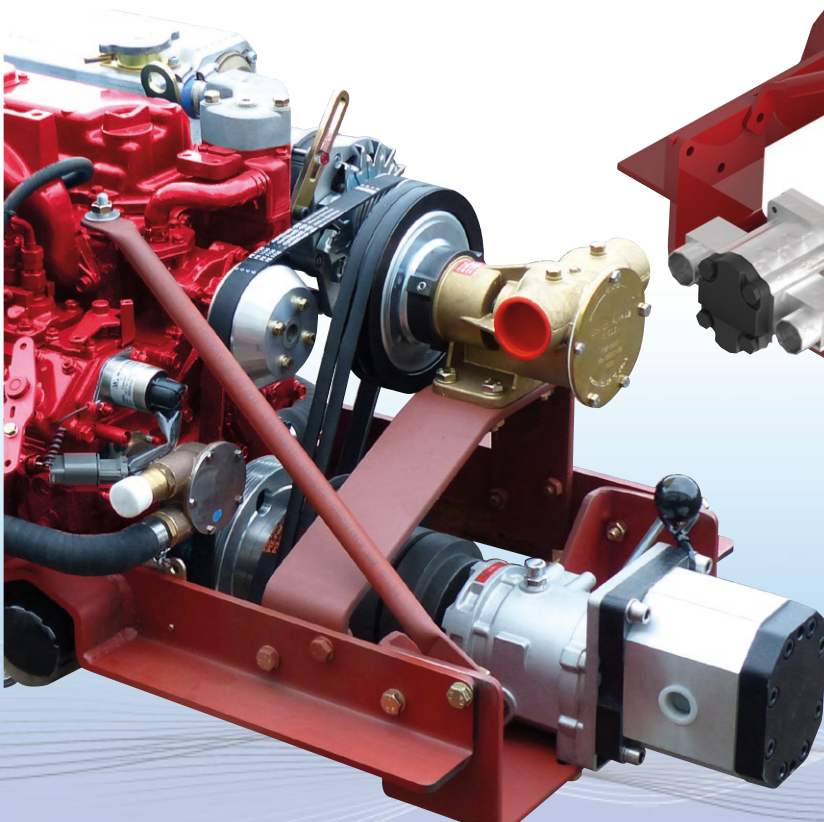

## Optional Power Take Off Solutions

Beta Marine can design, manufacture, supply and mount clutched or continuous running belt drive deck, bilge or air conditioning pumps etc. or alternatively design, manufacture and install PTO shafts and extended engine rails for the customer to self mount attachment's.

# 3D Computer Aided Design

## Optional Special Feet Service

Beta Marine engines have been fitted into thousands of vessels around the world using our standard engine feet but when necessary we can design, manufacture and supply "Special Engine Feet" so that your engine drops straight onto your vessels existing engine bearers.

### Step 1 – Designing Your Special Feet

Beta Marine will need to be advised of a number of accurate dimensions and or data to be able to produce a 3D model. There are different sets of information required, dependent upon your vessels bearer type, typically these are normally either Parallel, Stepped/Split Level or Down Angled. To help identify your vessels bearer type visit:

<http://www.betamarine.co.uk/seagoing-special-feet/>

Click on the most representative drawing as highlighted below. An online form will come into view detailing and clarify the information required for your installation type. The form can be printed off for reference and used when you next visit your vessel to obtain the necessary data. As a sense check, please take some photographs of the installation, these can be uploaded for Beta Marine technicians to refer to once you revisit the above, enter your data and submit your form.

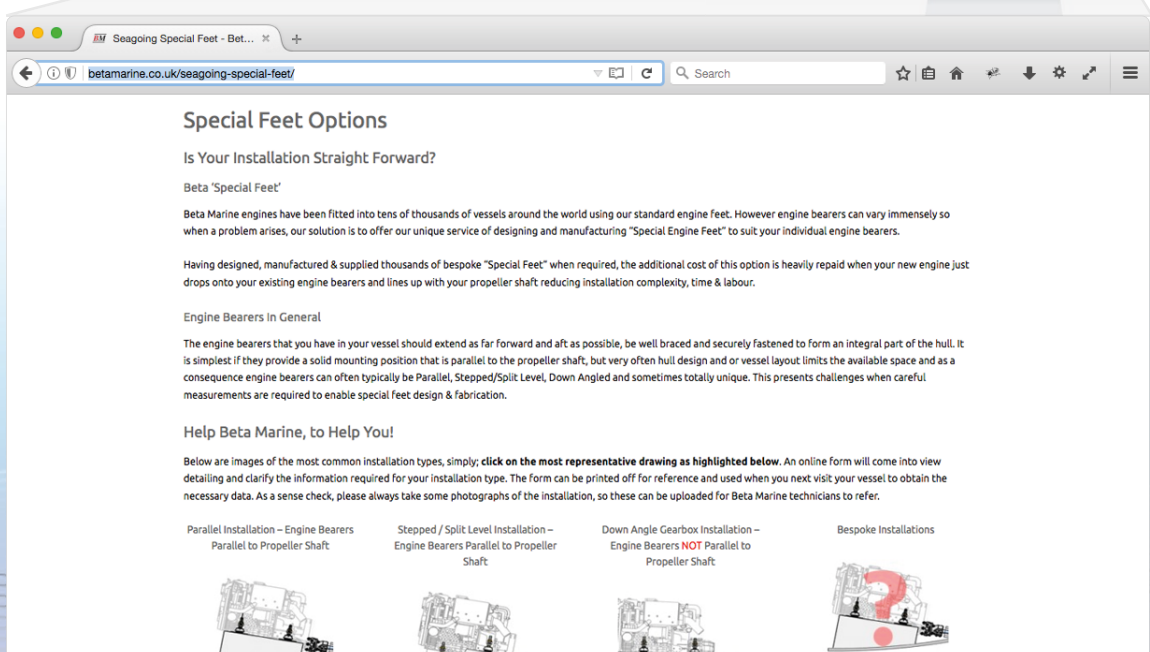
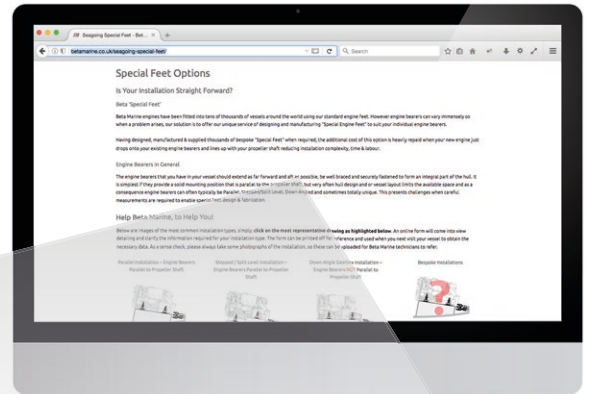



## Heat Exchanger Generating Sets - 4 to 58 kVA



Beta Marine has gained considerable experience over many years of manufacturing marine generating sets for yachts and work boats. These small marine generating sets are based on Kubota diesel engines with marine rated "generators" offering 4 kVA up to 58 kVA; and available as a standard open generating set or acoustically housed.

- Quality robust design - renowned for durability, longevity and reliability.
- Low noise levels as standard - especially when the acoustic housing option is taken.
- Keel cooled option is additionally available.

Our marine generating sets have high quality acoustic housings using 38mm acoustic material that are carefully designed to have compact dimensions and low weight, with all service connections brought to the outside of the housing - ready for a quick and easy installation.

Bespoke specification is a speciality. For full information please refer/or request: **Generating Set Range, 4 to 58 kVA, Publication Ref: SB 221-05164**



## **Saildrive Engine Range Heat Exchanger Cooled - Beta 14 to Beta 60**



Using the renowned Kubota based diesel engines Beta Marine has developed 2 solutions for vessels that require saildrives.

### **Saildrive Solution 1: Replacement Engine & Saildrive Leg**

The Beta Marine replacement engine and saildrive solution comprises of an appropriate new engine of choice fitted with a shallow sump mated to a Technodrive SeaProp 60 saildrive. Which when used in combination with our special feet option will drop into your existing Volvo or Yanmar saildrive GRP moulding.

Engines are available from 13.5 hp up to 56 hp. For full information please refer/or request: **Saildrive Engine Range, Beta 14 - Beta 60, Publication Ref: SB 221-004873**

### **Saildrive Solution 2: Replacement Engine with Adaptor for Existing Saildrive Leg**

The Beta Marine engine with adaptor solution consists of an appropriate engine of choice which is fitted with a shallow sump and a housing adaptor plate which can allow it to be mounted directly to your existing; Volvo 110S, Volvo 120S, Volvo 130S, Yanmar SD20 or Bukh saildrive.

## Notes...

**Notes...**



# ***BETA MARINE***

Beta Marine Limited, Davy Way, Waterwells, Quedgeley, Gloucester, GL2 2AD. UK.

Tel: +44 (0)1452 723492 Fax: +44 (0)1452 883742 Email: [sales@betamarine.co.uk](mailto:sales@betamarine.co.uk) Website: [www.betamarine.co.uk](http://www.betamarine.co.uk)

Ref: SB 221-06599 REV 14 - 1121